

FOREWORD

This manual contains a number of instructions and safety recommendations regarding driving, handling, lubrication, maintenance, inspection and adjustment of the skid steer loader. The manual is to promote safety maintenance and enhance machine performance.

Keep this manual handy and have all personnel read it periodically.

If you sell the machine, be sure to give this manual to the new owners.

This machine complies with EC directive "2006/42/EC".

1. **Read** and **understand** this manual before operating the machine.

This operator's manual may contain attachments and optional equipment that are not available in your area. Please consult your local Hyundai distributor for those items you require.

Improper operation and maintenance of this machine can be hazardous and could result in serious injury or death.

Some actions involved in operation and maintenance of the machine can cause a serious accident, if they are not done in a manner described in this manual.

The procedures and precautions given in this manual apply only to intended uses of the machine. If you use your machine for any unintended uses that are not specifically prohibited, you must be sure that it is safe for you and others. In no event should you or others engage in prohibited uses of actions as described in this manual.

2. **Inspect** the jobsite and **follow** the safety recommendations in the **safety hints** section before operating the machine.

3. Use **genuine Hyundai spare parts** for the replacement of parts.

We expressly point out that Hyundai will not accept any responsibility for defects resulting from non-genuine parts or non workmanlike repair.

In such cases Hyundai cannot assume liability for any damage.

Continuing improvements in the design of this machine can lead to changes in detail which may not be reflected in this manual. Consult Hyundai or your Hyundai distributor for the latest available information for your machine or for questions regarding information in this manual.

BEFORE SERVICING THIS MACHINE

It is the responsibility of the owner and all service and maintenance personnel to avoid accidents and serious injury by keeping this machine properly maintained.

It also is the responsibility of the owner and all service and maintenance personnel to avoid accidents and serious injury while servicing the machine.

No one should service or attempt to repair this machine without proper training and supervision.

All service and maintenance personnel should be thoroughly familiar with the procedures and precautions contained in this manual.

All personnel also must be aware of any federal, state, provincial or local laws or regulations covering the use and service of construction equipment.

The procedures in this manual do not supersede any requirements imposed by federal, state, provincial or local laws.

HYUNDAI can not anticipate every possible circumstance or environment in which this machine may be used and serviced.

All personnel must remain alert to potential hazards.

Work within your level of training and skill.

Ask your supervisor if you are uncertain about a particular task. Do not try to do too much too fast.

Use your common sense.

TABLE TO ENTER SERIAL NO. AND DISTRIBUTOR	
--	--

Machine Serial No.	
Engine Serial No.	
Manufacturing year	
Manufacturer Address	Hyundai Heavy Industries co., Ltd. 1 Chonha-Dong, Dong-Ku Ulsan The Republic of Korea.
Distributor for U.S.A Address	Hyundai Heavy Industries U.S.A, Inc 955 Estes Avenue EIK Grove village IL, 60001 U.S.A
Distributor for Europe Address	Hyundai Heavy Industries Europe N. V. Vossendal 11 2240 Geel Belgium
Dealer Address	

EC REGULATION APPROVED

- Noise level (EN474-1 : 2006 and 2000/14/EC) are as followings.

LPA : 86 dB

LWA : 101 dB

- The value of vibrations transmitted by the operator's seat are lower than standard value of (EN474-1 : 2006 and 2002/44/EC).

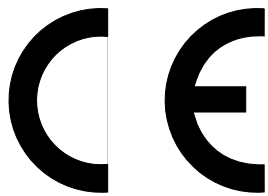

SAFETY LABELS

1. LOCATION

Always keep these labels clean. If they are lost or damaged, attach them again or replace them with a new label.

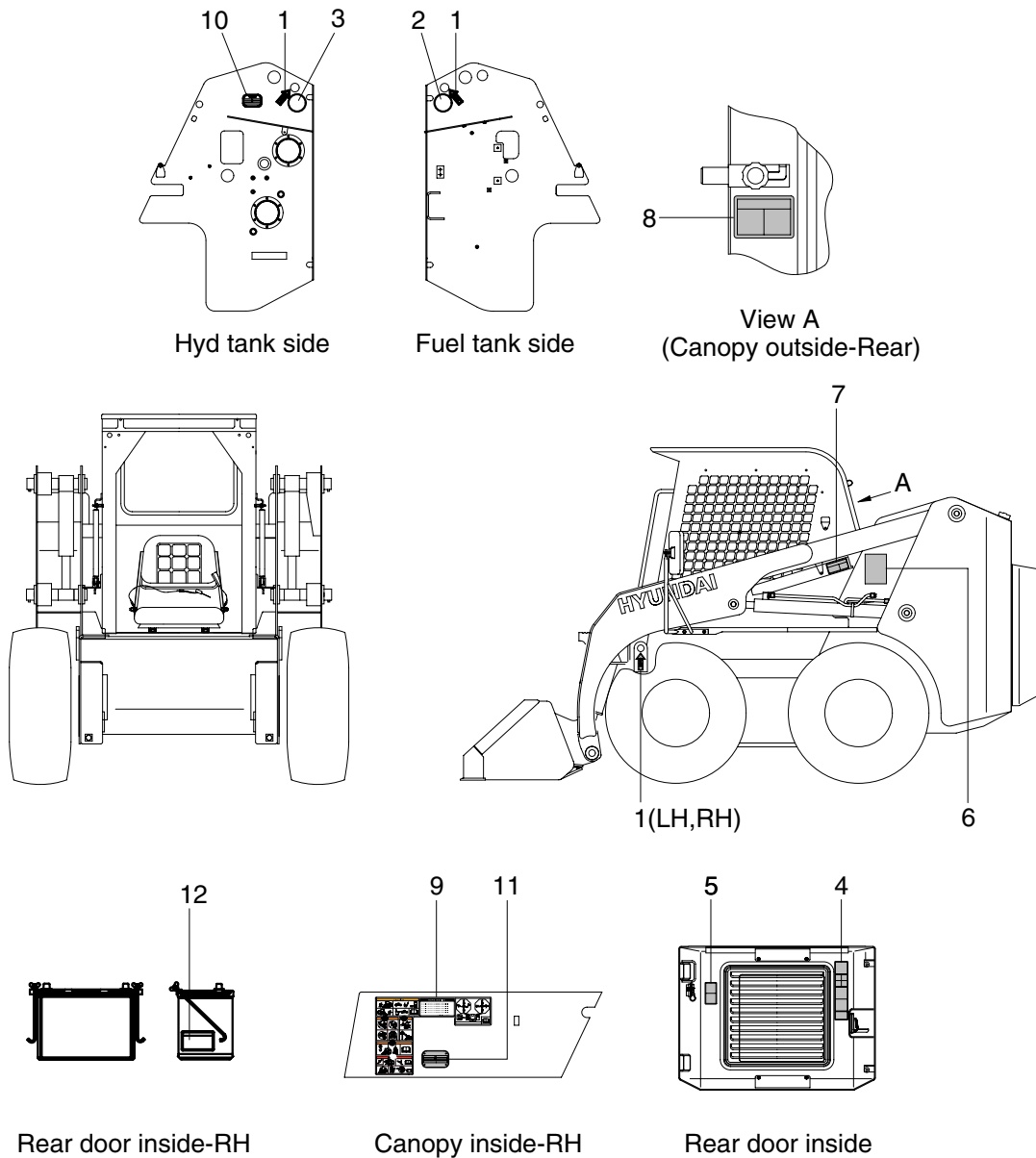

- | | | | |
|---|----------------------|----|-----------------------|
| 1 | Slingshield ideogram | 7 | Boom lock |
| 2 | Fueling | 8 | Canopy lock |
| 3 | Hydraulic oil level | 9 | General warning |
| 4 | Engine room | 10 | Name plate |
| 5 | Stay | 11 | ROPS serial no. plate |
| 6 | Service instruction | 12 | ECU connector |

6507A0FW04

2. DESCRIPTION

There are several specific warning labels on this machine please become familiarized with all warning labels.

Replace any safety label that is damage, or missing.

1) FUELING(Item 2)

This warning label is positioned on the side of fuel tank.

- ▲ Stop the engine when refueling. All lights or flames shall be kept at a safe distance while refueling.

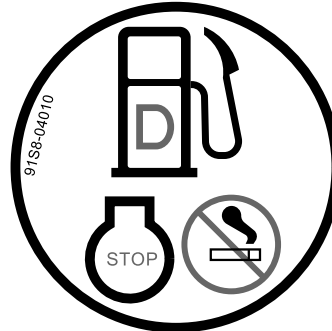

80070FW05

2) HYDRAULIC OIL LEVEL(Item 3)

This warning label is positioned on the side of hydraulic oil tank.

- ▲ Place the bucket on the ground whenever servicing the hydraulic system.
- ※ Check oil level on the level gauge. Refill the recommended hydraulic oil up to specified level if necessary.
- ※ Do not mix with different brand oil.
- ▲ Avoid the hazard by relieving pressure before disconnecting hydraulic or other lines. Tighten all connections before applying pressure.

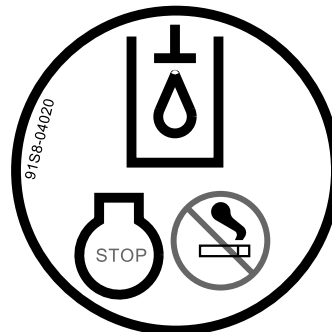

80070FW06

3) ENGINE ROOM(Item 4)

This warning label is positioned on the inside of the rear door.

- ▲ Do not touch tail pipe or it may cause severe burn.
- ▲ Never open the filler cap while engine running or at high coolant temperature.
- ▲ Don't open the engine door during the engine's running.



80070FW07

4) **STAY**(Item 5)

This warning label is positioned on the inside of the rear door.

- ⚠ **Be sure to support the stay when the door needs to be opened.**
- ⚠ **Be careful that the opened door may be closed by the external or natural force like strong wind.**

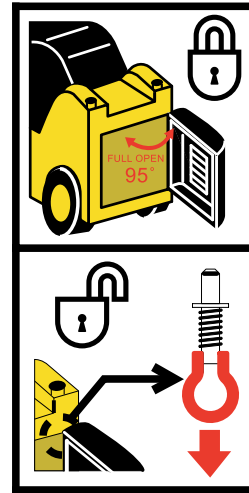

80070FW08

5) **BOOM LOCK**(Item 7)

This warning label is positioned on the boom lock device.

- ⚠ **When working under or around the bucket, with bucket raised, boom lock device must be engaged.**

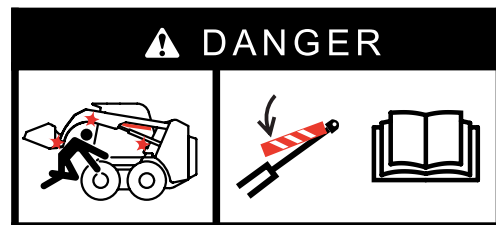

80070FW09

6) **CANOPY LOCK**(Item 8)

This warning label is positioned on the rear outside of the canopy.

- ⚠ **Be sure to support the lock pin.**

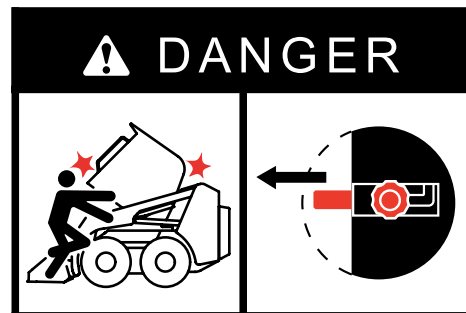

80070FW10

7) **SLINGING IDEOGRAM**(Item 1)

This label is indicate point of lifting or fixing.

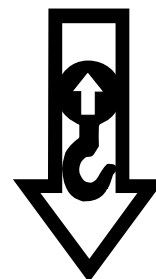

80070FW11

8) ECU connector(Item 12)

This warning label is positioned on the side of the battery box.

⚠ Before carrying out any electric welding on this machine

- Pull the connectors out of all electronic control units.
- Connect the ground lead of the welding equipment as close to the welding point as possible.

Refer to the page 6-27 for details.

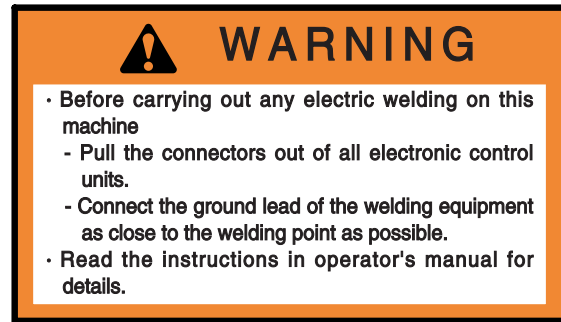

7803AFW20

MACHINE DATA PLATE

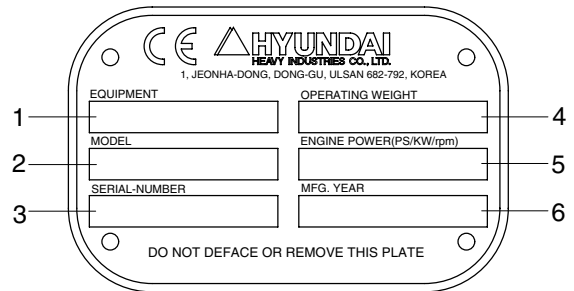
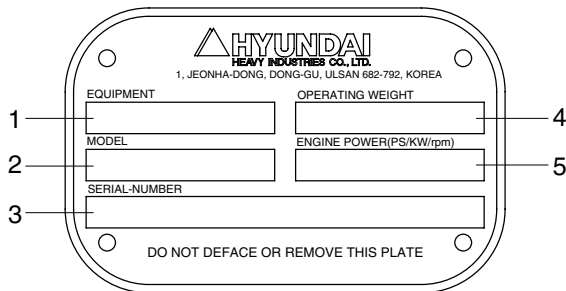

FOR EU ONLY

21090FW10

- | | | | | | |
|---|------------|---|------------------|---|--------------------|
| 1 | Equipment | 3 | Serial number | 5 | Engine power |
| 2 | Model name | 4 | Operating weight | 6 | Manufacturing year |

※ The machine serial number assigned to this particular machine and should be used when requesting information or ordering service parts for this machine from your authorized HYUNDAI dealer. The machine serial number is also stamped on the frame.

GUIDE

1. DIRECTION

The direction of this manual indicate forward, backward, right and left when machine is in the traveling direction.

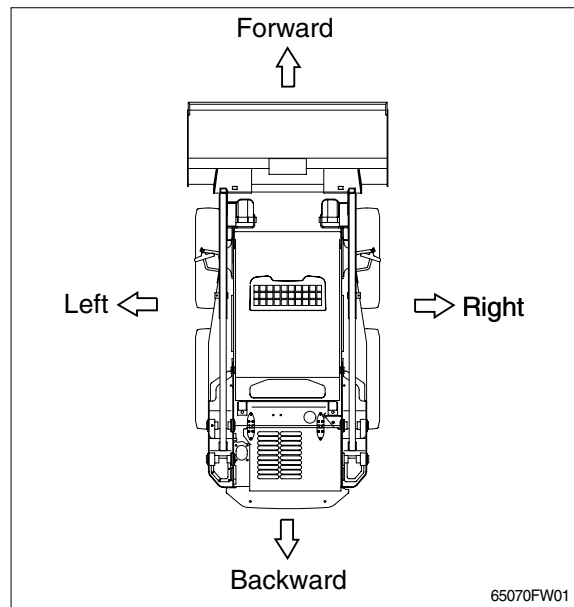

2. SERIAL NUMBER

Inform following when you order parts or the machine is out of order.

1) MACHINE SERIAL NUMBER

The machine serial number plate is located on the side of the hydraulic tank.

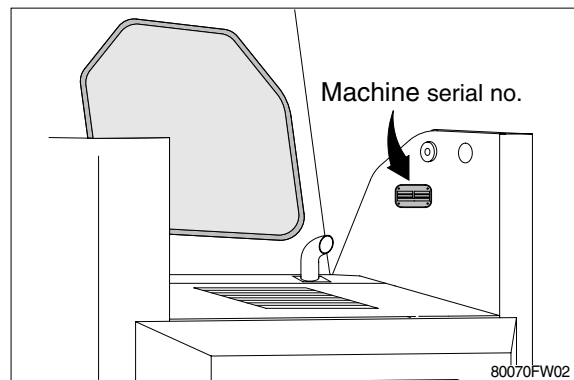

2) ENGINE SERIAL NUMBER

The numbers are located on the engine name plate.

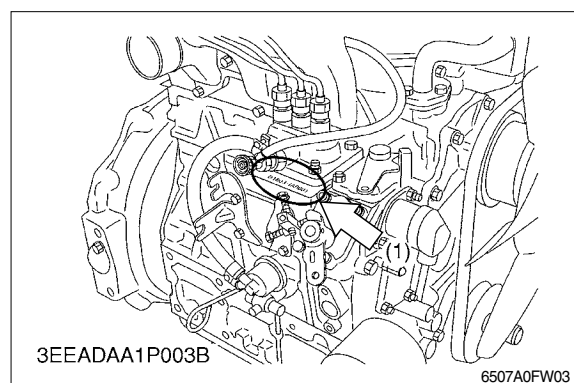

3. SYMBOLS

▲ Important safety hint.

△ It indicates matters which can cause the great loss on the machine or the surroundings.

※ It indicates the useful information for operator.

Foreword	0-1
Before servicing this machine	0-2
Table to enter S/No. and distribution	0-3
EC regulation approved	0-4
Safety label	0-5
Machine data plate	0-9
Guide(Direction, S/No., Symbol)	0-10

1. SAFETY HINTS

1. Before operating the machine	1-1
2. During operating the machine	1-5
3. During maintenance	1-12
4. Parking	1-16

2. SPECIFICATIONS

1. Major components	2-1
2. Specifications	2-2
3. Weight	2-3
4. Specification for major components	2-4

3. CONTROL DEVICES

1. Locations	3-1
2. Warning indicator panel	3-2
3. Operating levers and switches	3-6
4. Air conditioner and heater(Cab type)	3-11
5. Others	3-13

4. OPERATION

1. Suggestion for new machine	4-1
2. Check before starting the engine	4-2
3. Normal starting	4-3
4. Starting engine in a cold weather	4-4
5. Jump starting	4-5
6. To stop the engine	4-6

7. Warming-up operation	4-7
8. Operation of the working device	4-8
9. Machine operation	4-10
10. Bucket installation	4-12
11. Bucket removal	4-13
12. Engaging and disengaging the boom lock device	4-14
13. Raising and lowering the operator canopy	4-16
14. Materials handling operation	4-18
15. Operation in the special working sites	4-22
16. Long term storage	4-24

5. TRANSPORTATION

1. Road traveling	5-1
2. Transportation	5-2
3. Loading and unloading by crane	5-3

6. MAINTENANCE

1. Instructions	6-1
2. General maintenance	6-3
3. Tightening torque	6-4
4. Specification of fuel, coolant and lubricants	6-6
5. Maintenance check list	6-8
6. Maintenance chart	6-10
7. Service instruction	6-12
8. Electrical system	6-26

7. TROUBLESHOOTING GUIDE

1. Engine	7-1
2. Electrical system	7-2
3. Hydraulic system	7-3