

1. SAFETY HINTS

1. BEFORE OPERATING THE MACHINE

Think-safety first.

In special situation, wear protective clothing including a safety helmet, safety shoes, gloves, safety glasses and ear protection as required by the job condition.

Almost every accident are caused by disregarding the simple and fundamental safety hints.

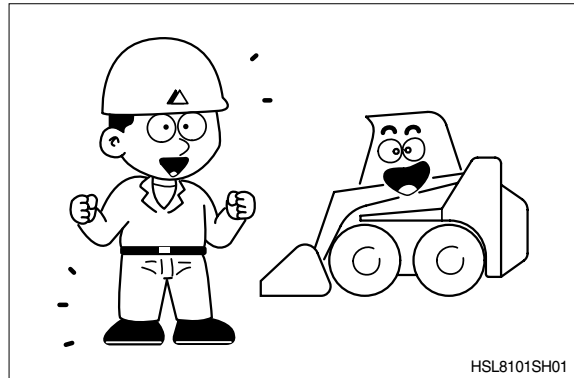

Be sure to understand thoroughly all about the operator's manual before operating the machine.

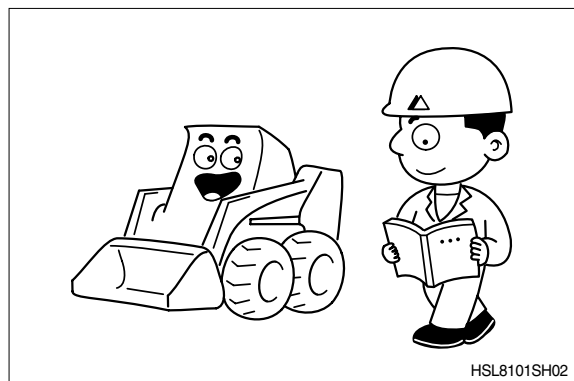

Fully understand the details and process of the construction before starting the work.

If you find anything dangerous on the job, consult with the job supervisor for the preventive measures before operating the machine.

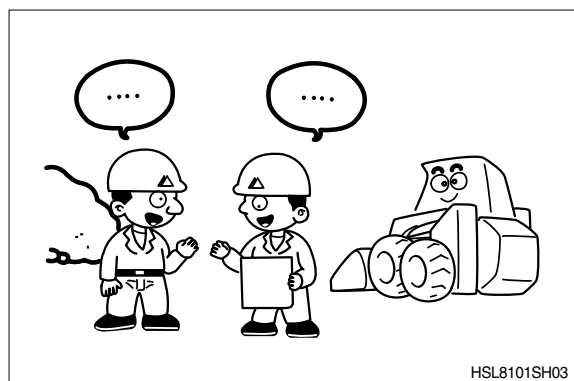

Do not operate when tired, or after drinking alcoholic beverages, or any type of drugs.

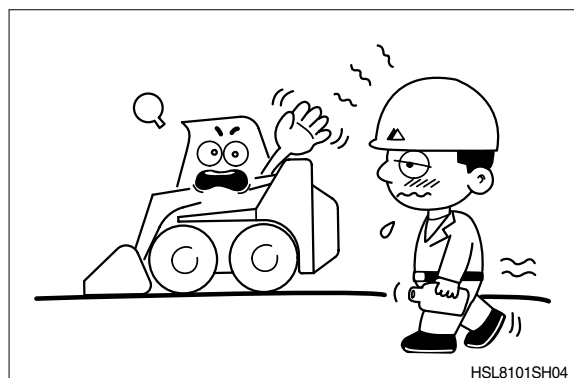

Check daily according to the operation manual.

Repair the damaged parts and tighten the loosened bolts.

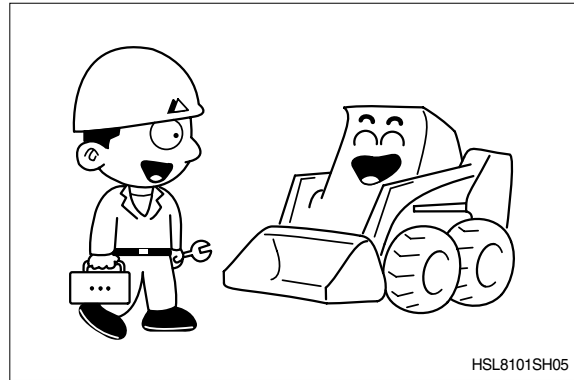

Check for leakage of engine oil, hydraulic oil, fuel and coolant.

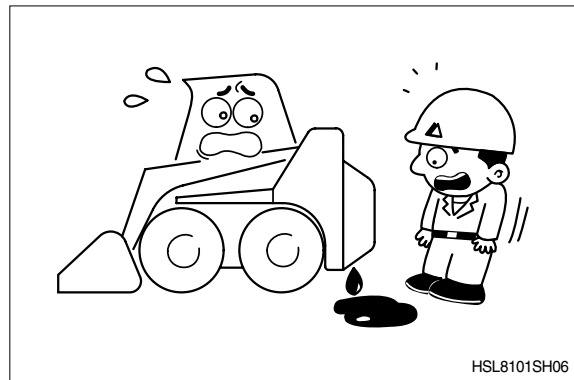

Do not operate the machine if it requires repairs.
Operate after complete repair.

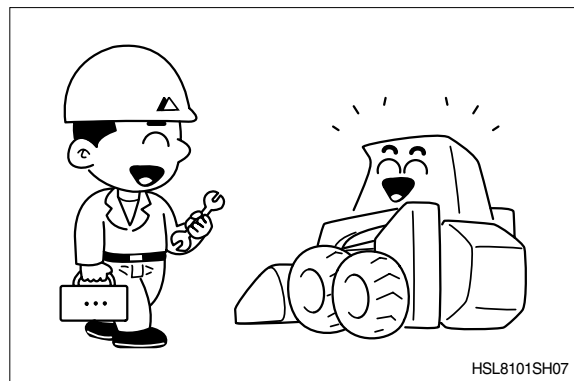

Learn about the safety devices on your own machine and how to use them. Confirm if they are correctly attached in the prescribed position. Such safety devices include.



PRECAUTIONS FOR ATTACHMENTS

When installing and using an optional attachment, read the instruction manual for the attachment and the information related to attachments in this manual.

Do not use attachments that are not authorized by or your distributor. Use of unauthorized attachments could create a safety problem and adversely affect the proper operation and useful life of the machine.

Any injuries, accidents, product failures resulting from the use of unauthorized attachments will not be the responsibility of Hyundai.

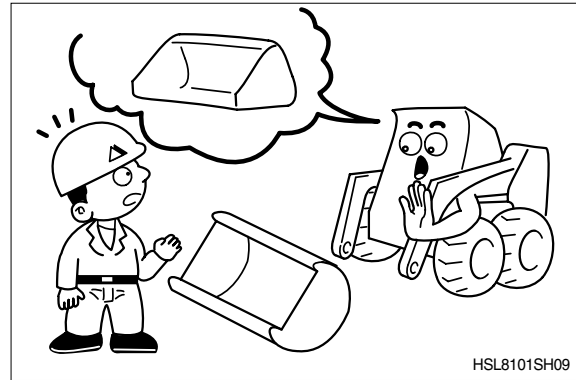

SAFETY RULES

Only trained and authorized personnel can operate and maintain the machine.

Follow all safety rules, precautions and instructions when operating or performing maintenance on the machine.

When working with another operator or a person on worksite traffic duty, be sure all personnel understand all hand signals that are to be used.

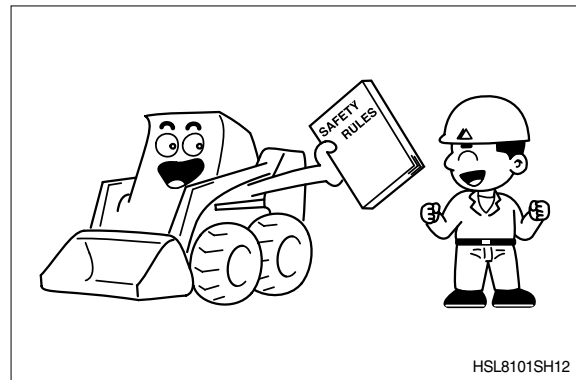

SAFETY FEATURES

Be sure all guards and covers are in their proper position. Have guards and covers repaired if damaged.

Use safety features such as the safety lock lever and seat belts properly.

Never remove any safety features. **Always** keep them in good operating condition.

Improper use of safety features could result in serious bodily injury or death.

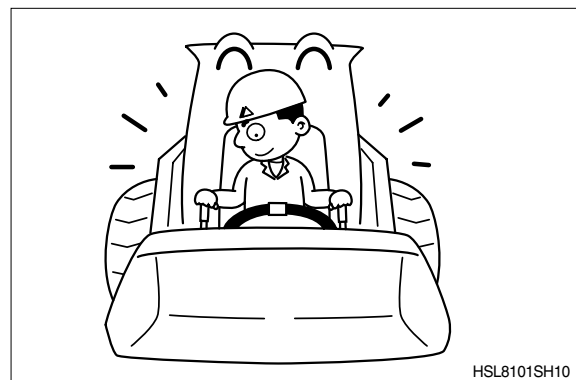

EMERGENCY EXIT

If by accident the front of the machine becomes blocked so that you can not exit through the front of the machine, you can exit through the rear of the machine after removing the rear window. Refer to the page 3-12 for detail

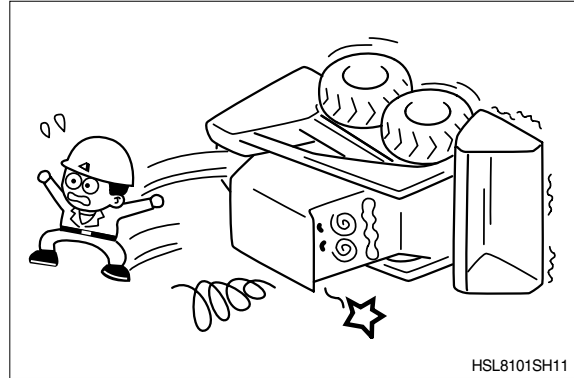

FIRE EXTINGUISHER AND FIRST AID KIT

Be sure fire extinguishers have been provided and know how to use them.
Provide a first aid kit at the storage point.
Know what to do in the event of a fire.
Be sure you know the phone numbers of persons you should contact in case of an emergency.

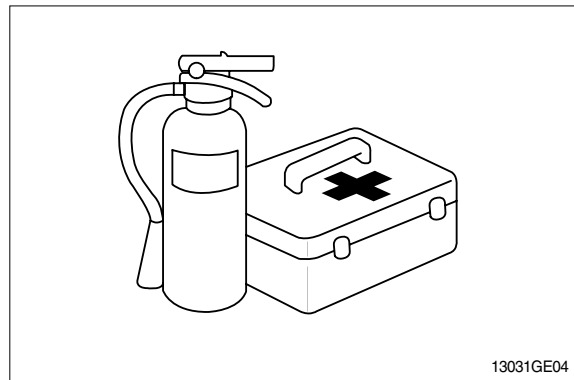

UNAUTHORIZED MODIFICATION

Any modification made without authorization from Hyundai can create hazards.
Before making a modification, consult your Hyundai distributor. Hyundai will not be responsible for any injury or damage caused by any unauthorized modification.

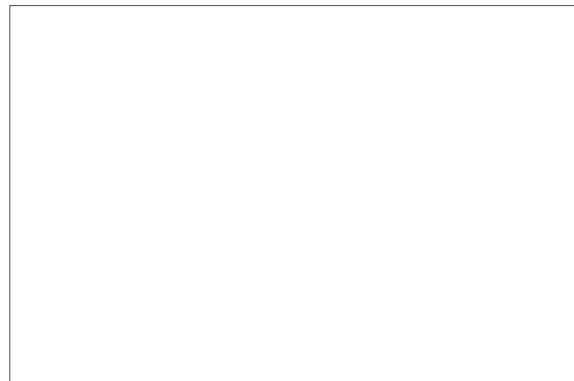

SEAT BELT & SEAT BAR

Check the condition of the seat belt and mounting hardware before operating the machine.
Replace the seat belt at least once every three years regardless of appearance.
Always use seat belts and seat bar when operating your machine.

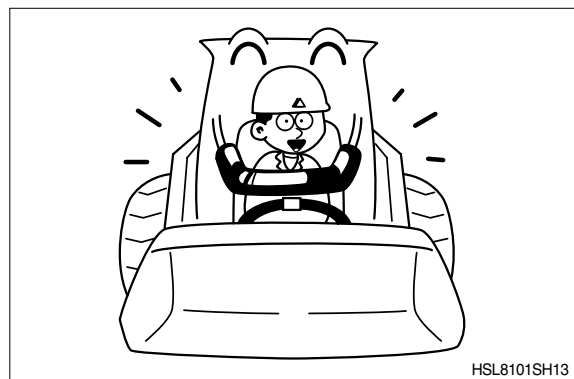

2. DURING OPERATING THE MACHINE

Use the handle and footstep when getting on or off the machine.

Do not jump on or off the machine.

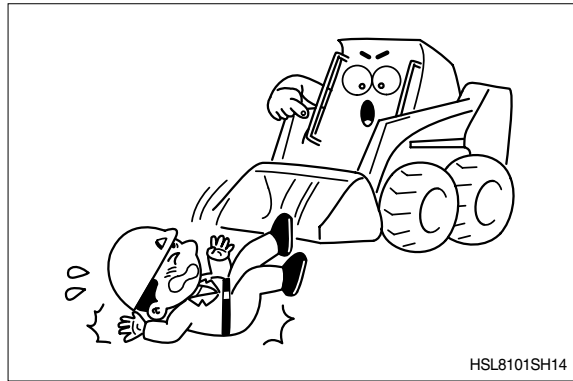

Sound the horn to warn nearby personnel before operating the machine.

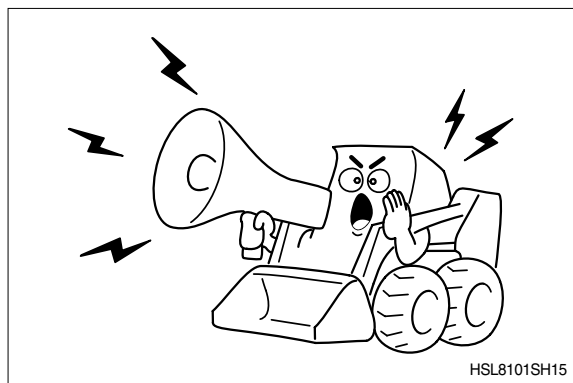

Operate carefully to make sure all personnel or obstacles are clear within the working range of the machine.

Place safety guards if necessary.

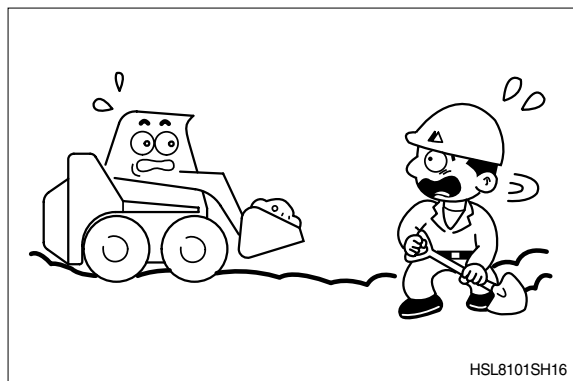

When using the work equipment, pay attention to jobsite.

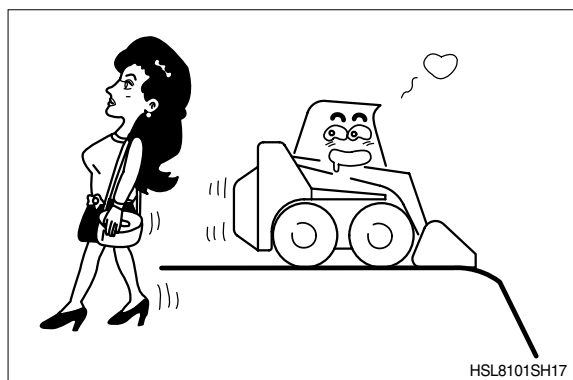

Provide proper ventilation when operating engine in a closed area to avoid the danger of exhaust gases.

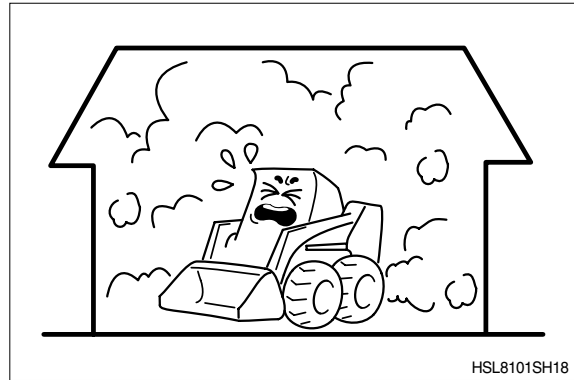

HSL8101SH18

Check the locations of underground gas pipes or water line and secure the safety before operation.

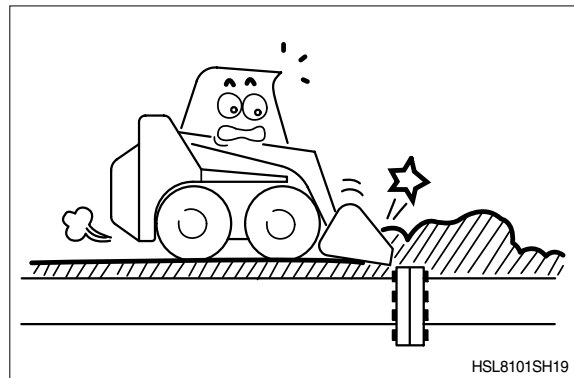

HSL8101SH19

The operating near the electrical lines is very dangerous. Operate within safe working range permitted as below.

Supply voltage	Min safe separation
6.6kV	3m(10ft)
33.0kV	4m(13ft)
66.0kV	5m(16ft)
154.0kV	8m(26ft)
275.0kV	10m(33ft)

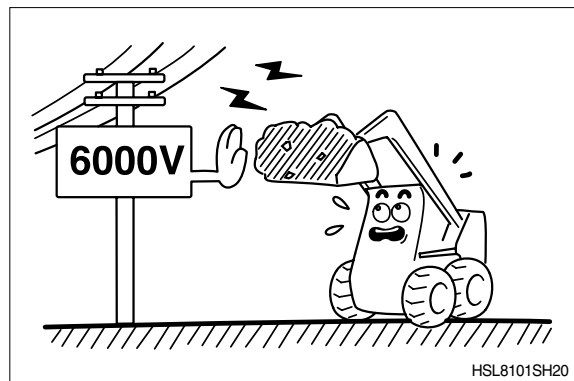

HSL8101SH20

If the machine touches the electric power lines, keep sitting on the operator's seat and make sure the personnel on the ground not to touch the machine until turning off the electric current. Jump off the machine, do not contact the machine when you need to get off.

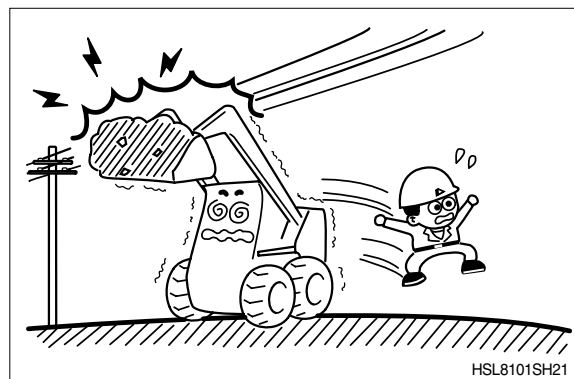

HSL8101SH21

While traveling on public roads, lift the bucket 20~30cm above the ground. Do not drive with the bucket loaded.

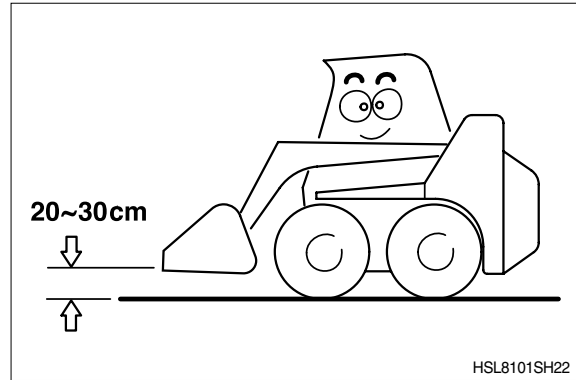

When the bucket is loaded, avoid sudden swinging or starting. Overloading is dangerous. Make sure the load does not exceed the permissible level.

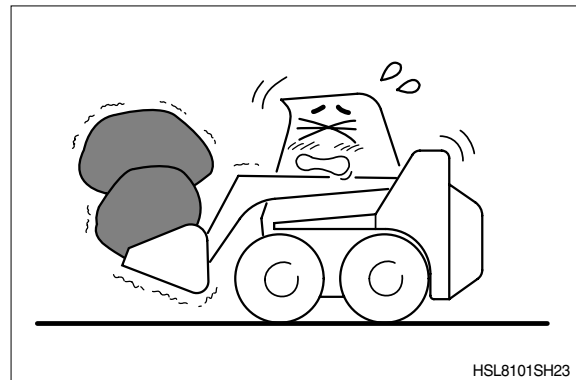

The operation on a slope is dangerous. Avoid operating the machine on a slope of over 10 degree.

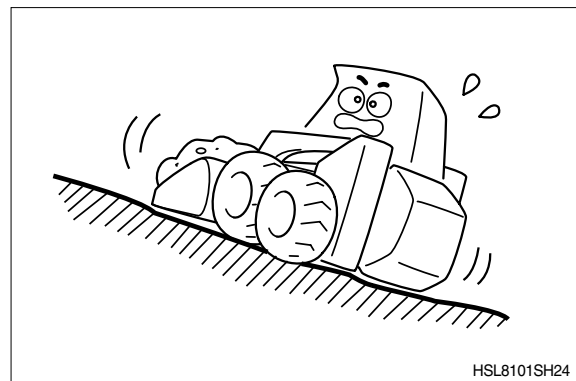

Operate the machine after making ground flat when operation is required on a slope.

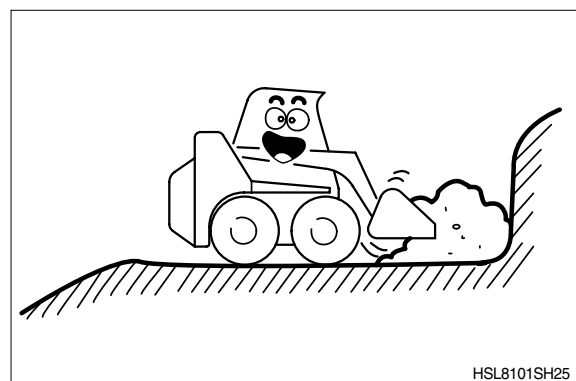

Avoid parking and stopping on a slope.
Lower the bucket to the ground and block the tire when parking.

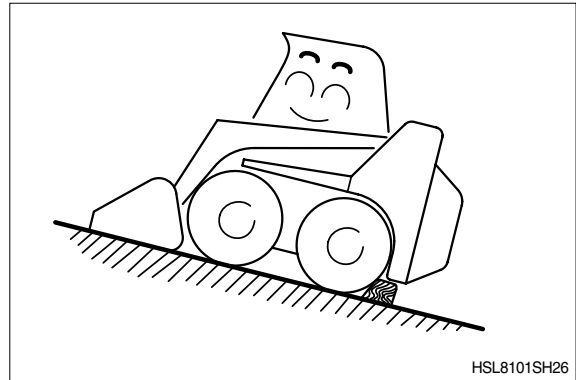

Avoid traveling in a cross direction on a slope as it can cause the danger of rolling over and sliding.

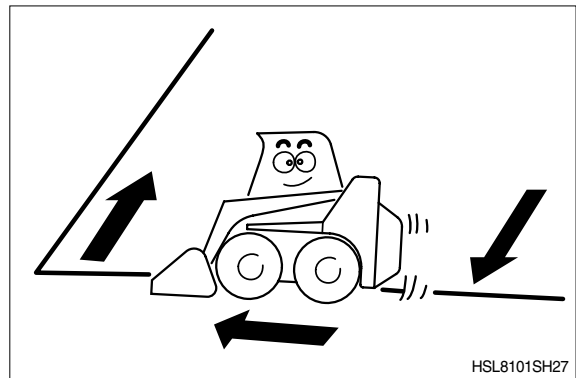

Traveling on the slope is dangerous.
Be sure to operate slowly when driving down a slope and maintain the bucket at a height of 20~30cm(1ft) above the ground so that it can be used as brake in an emergency.

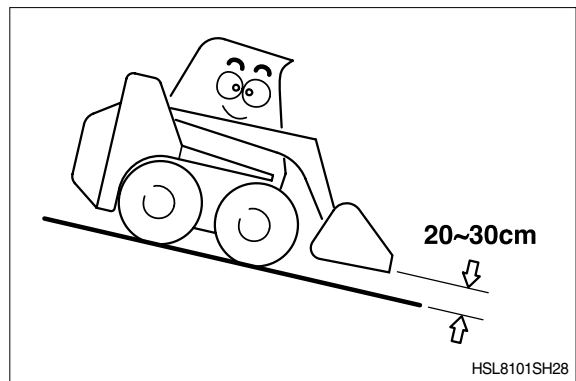

Steering of the machine while traveling on a slope is dangerous.
When an inevitable turning of direction is required, turn on the flat and solid ground.

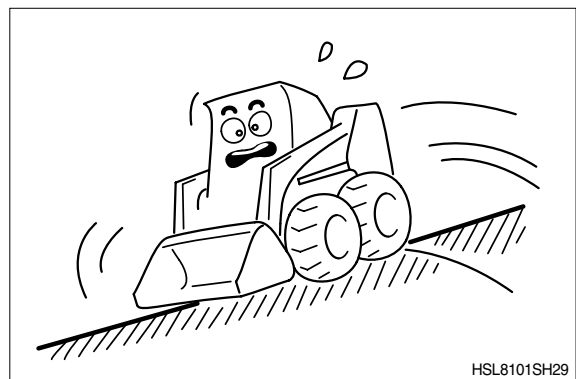

The engine angularity limits are 20 degree.
Do not operate by more than the engine limits in any case.

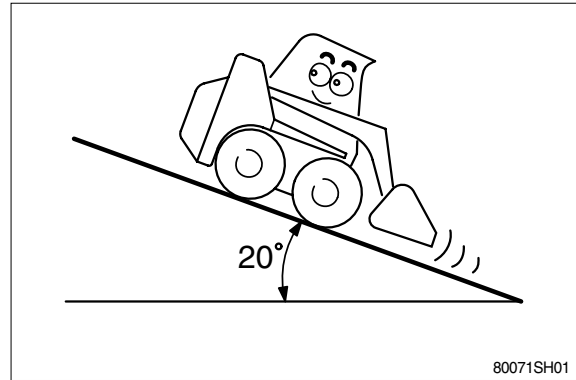

Watch out for obstacles. Be particularly careful to check the machine clearance during steering.

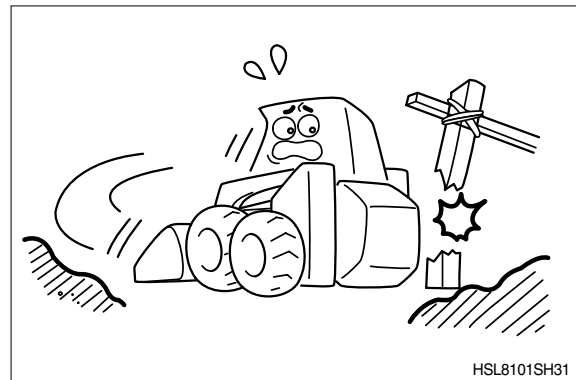

Always operate machine with proper ROPS/FOPS installed.
Do not attempt to repair a rollover protective structure(ROPS) after an accident.
Repaired structures do not provide the original structure and protection.
Test and approved as a protective CANOPY according to ROPS and FOPS standard.
Meets : ISO 3471/3449/3164
Meets :SAE J1040/J1043/J397

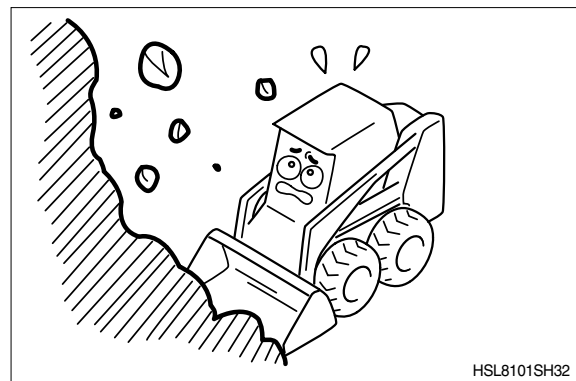

Avoid operating on a cliff, or soft ground as there is danger of rolling over.
Take necessary precautions when working after rain, or blasting because the ground may not be firm enough.

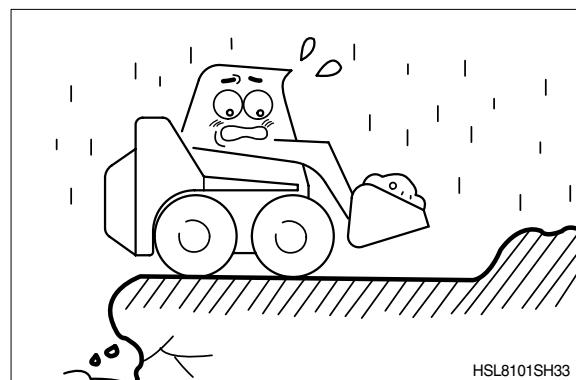

This machine is intended to be used only for excavation and loading. Do not use this for pulling up materials. Unlike a crane, this machine is not equipped with devices needed to pull up things.

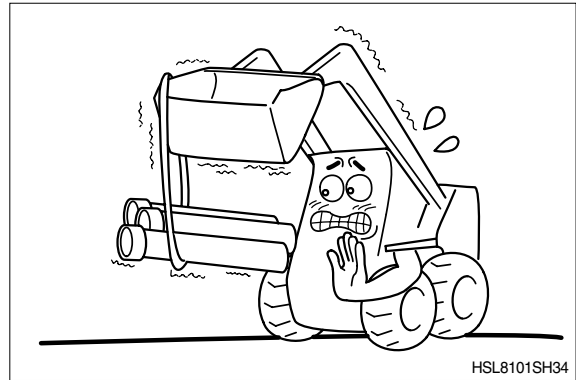

Slow down when traveling through obstacles or uneven ground.

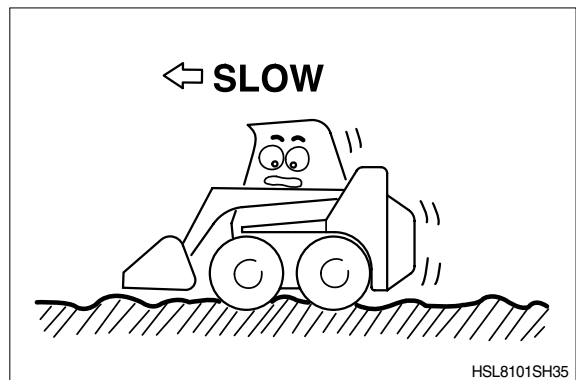

Use lights at night or in dark areas.

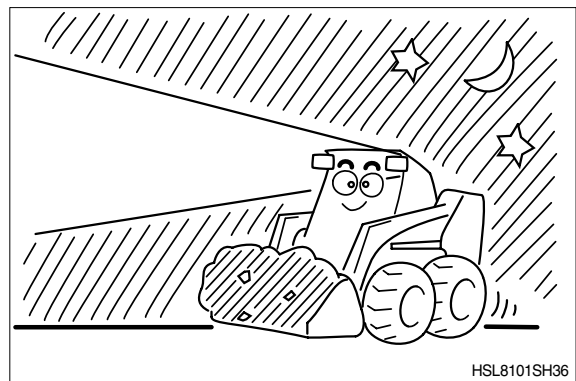

Be careful in the condition of bad clearance of sight caused by cloud, snow or rain.



Be careful when driving under a height limited place, for instance, a tunnel, an overpass, and an overhead cable.

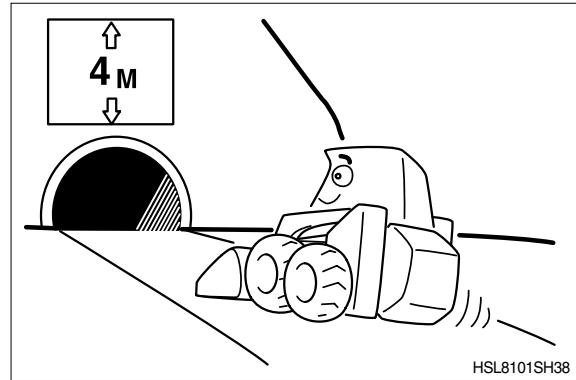

MOUNTING AND DISMOUNTING

Never jump on or off the machine. **Never** get on or off a moving machine.

When getting on or off the machine, face the machine and use the handhold and steps.

Never hold any control levers when getting on or off the machine.

Always maintain three-point contact with the handholds and steps to ensure that your support yourself.

If there is any oil, grease, or mud on the handholds or steps, wipe it off immediately.

Always keep these parts clean. Repair any damage and tighten any loose bolts.

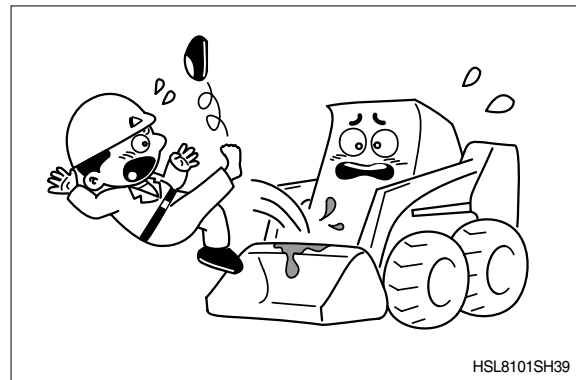

BEFORE YOU LEAVE THE OPERATOR'S SEAT

Lower the lift arms, put the attachment flat on the ground.

Stop engine.

Raise seat bar, move pedal until both lock.

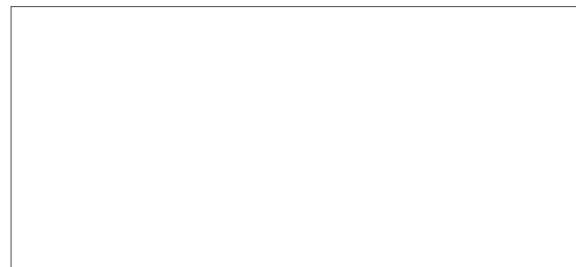

3. DURING MAINTENANCE

During maintenance do not allow any unauthorized person to stand near the machine. Also, be careful of people in the vicinity.

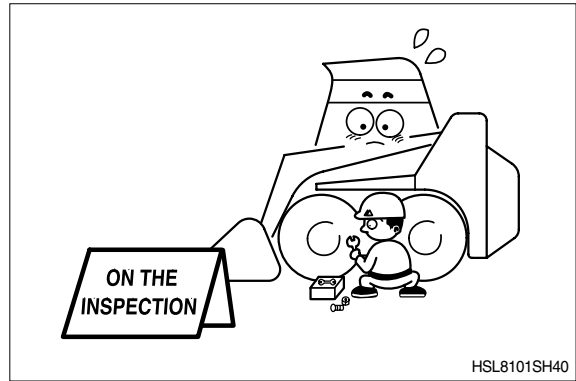

Stop the engine immediately when the trouble of the machine is found. Inspect immediately the cause of trouble such as vibration, overheating and trouble in the cluster then repair.

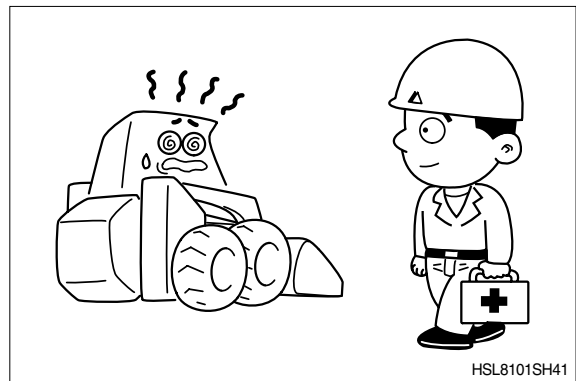

Park on a flat place for inspecting and repairing and properly TAG machine is not operational. (Remove start key) Extreme care shall be taken during maintenance work. Parts may require additional safe guarding.

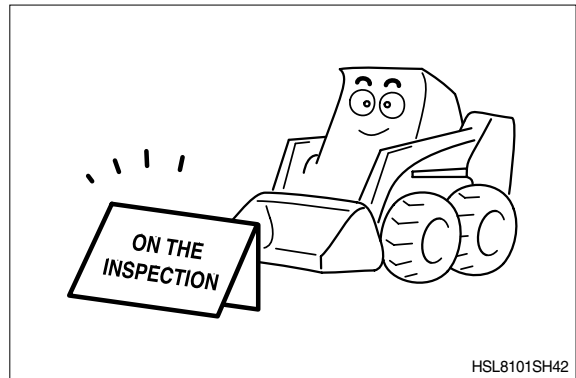

Do not remove the radiator cap from hot engine. Open the cap after the engine is cool, below 50°C(112°F) to prevent personal injury from heated coolant spray or steam.

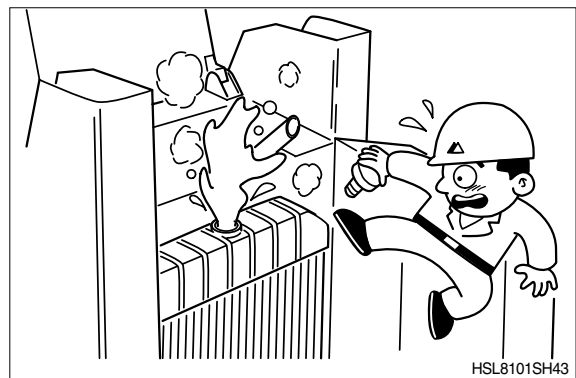

Do not work below the machine.
When working under or around the bucket or linkage, with the bucket raised, proper support must be provided for the bucket and/or the linkage.

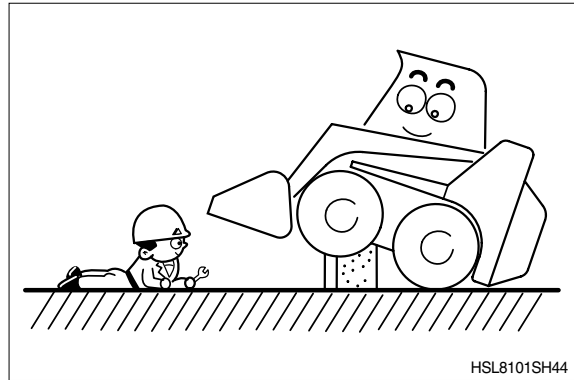

There is the danger of fire in fuel and oil.
Store in cool dry area, away from any open flames.
Do not refuel the machine while smoking or when near open flame or sparks.
Always stop engine before refueling machine.

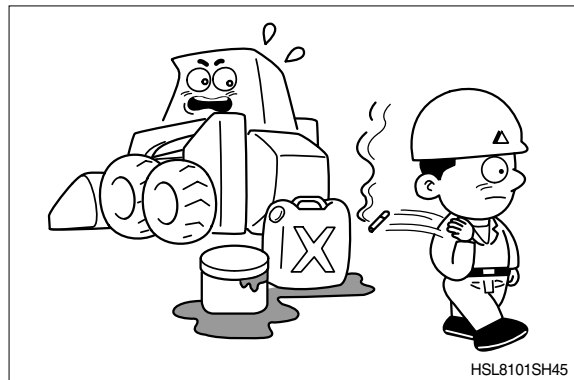

Spilled grease and oil are dangerous to safety.
Keep your machine always clean and dry.

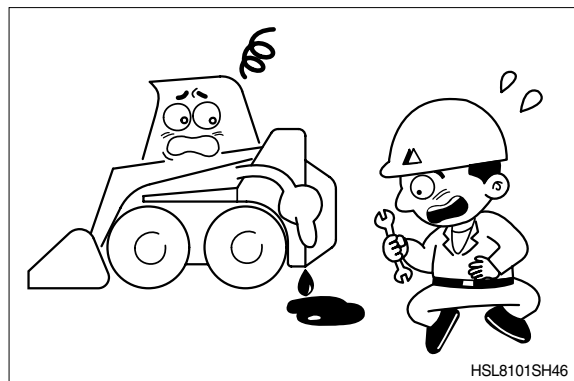

Disassembly, reassembly and repair of tire
requires special skills and equipment.
Contact a tire repair shop.

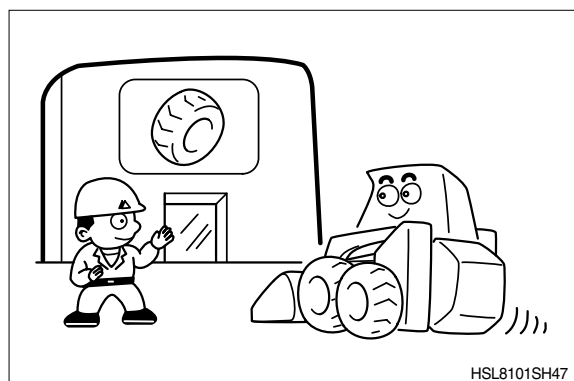

Do not touch exhaust pipe, or it may cause severe burn.

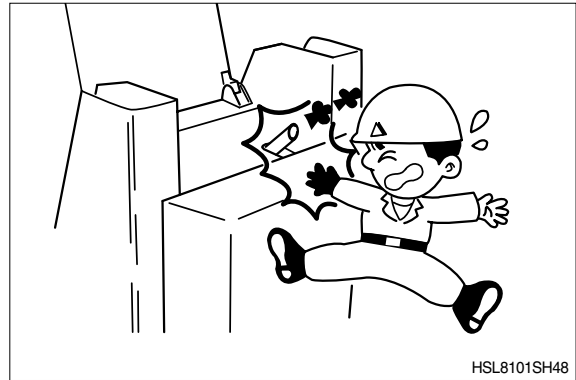

Be sure to support stay, when the engine cover needs to be opened.

Be careful the external or natural force like strong wind.

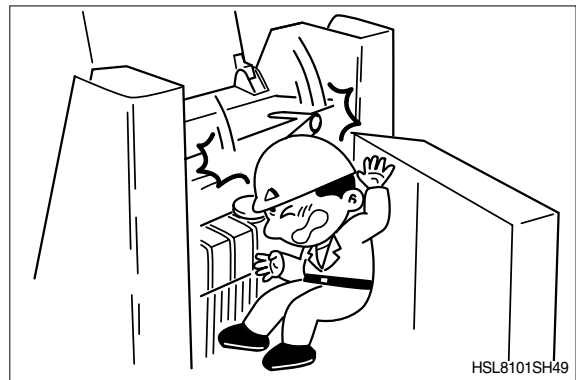

When servicing and checking engine compartment at the rear door and engine cover careful head against door

Do not open the rear door while engine is running

To prevent accidents, use care when working around rotating parts such as fan and belt pulley.

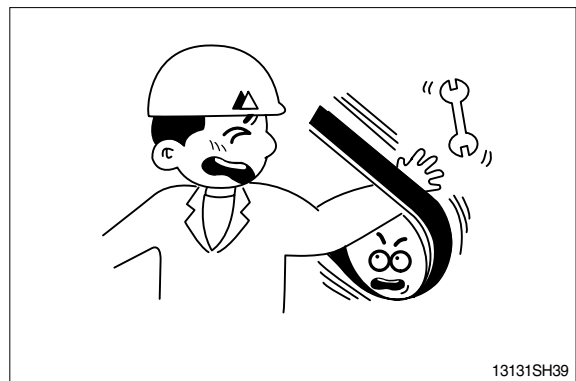

The anti-slip protection should be replaced if they have become worn or have been printed over.

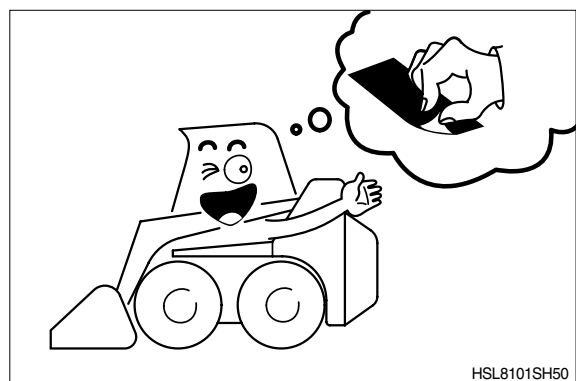

KEEP THE MACHINE CLEAN

Spilled oil or grease, or scattered tools or broken pieces are dangerous because they may cause you to slip or trip.

Always keep your machine clean and tidy.

If water gets into the electrical system, there is danger that the machine may not move or may move unexpectedly.

Do not use water or steam to clean the sensors, connectors, or the inside of the operator's compartment.

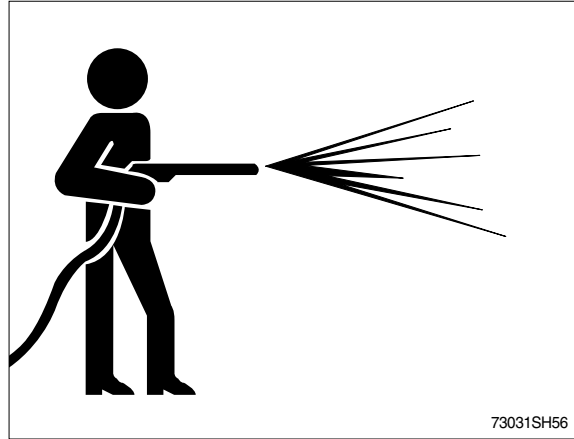

HANDLING TIRES

If tires are not used under the specified condition, they may overheat and burst or be cut and burst by sharp stones on rough road surfaces. This may lead to serious injury or damage.

Disassembly, reassembly and repair of tire requires special skills and equipment.

Contact a tire repair shop.

To maintain safety, always keep to the suitable conditions : See page 6-22.

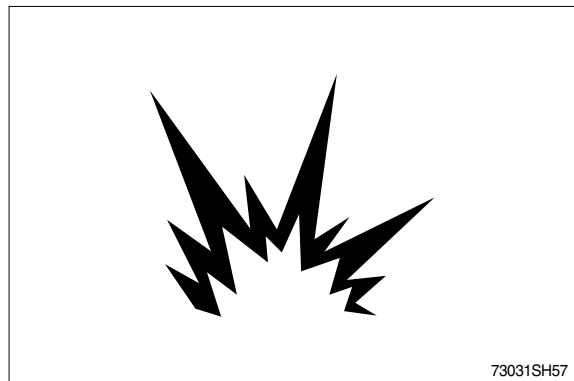

4. PARKING

When parking or leaving the loader, lower the booms, set the parking brake, shut off engine and remove key.

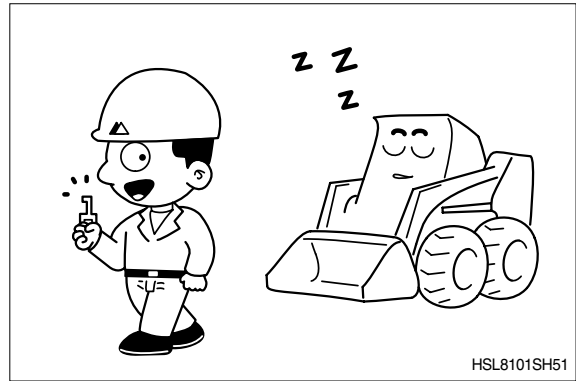

Park the machine in the flat and safe place.

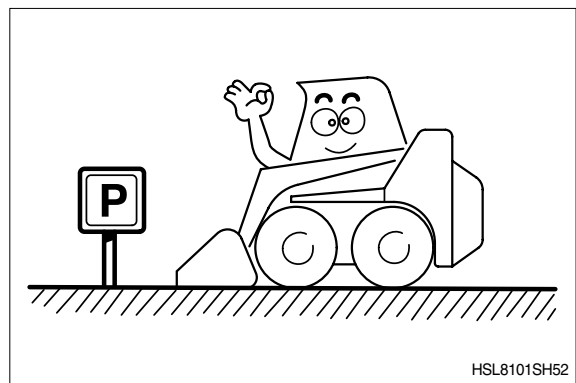

Hope you can work easily and safely observing safety rules.

For safe operation, observe all safety rules.

