

2. CHECK BEFORE STARTING THE ENGINE

1) Make sure that the steering frame lock bar is stored in the unlocked position.

▲ The steering frame lock bar must be removed in order to steer the machine.

2) Look around the machine and under the machine to check for loose nut or bolts, collection of dirt, or leakage of oil, fuel or coolant and check the condition of the work equipment and hydraulic system. Check also loose wiring, and collection of dust at places which reach high temperature.

※ **Refer to the daily check on the chapter 6, Maintenance.**

3) Adjust seat to fit the contours of the operator's body for the pleasant operation.

4) Make sure that the machine is equipped with a lighting system that is adequate for the job conditions. Ensure that all lights are in proper working condition.

5) Adjust the rear view mirror.

6) Make sure that there are no personnel in the area before you start the engine. Make sure that there are no personnel in area before you move the machine. Make sure that there are no personnel on the machine, underneath the machine, or around the machine.

▲ If a warning tag is attached to the starting switch or to the controls, do not start the engine. Also, do not move any controls.

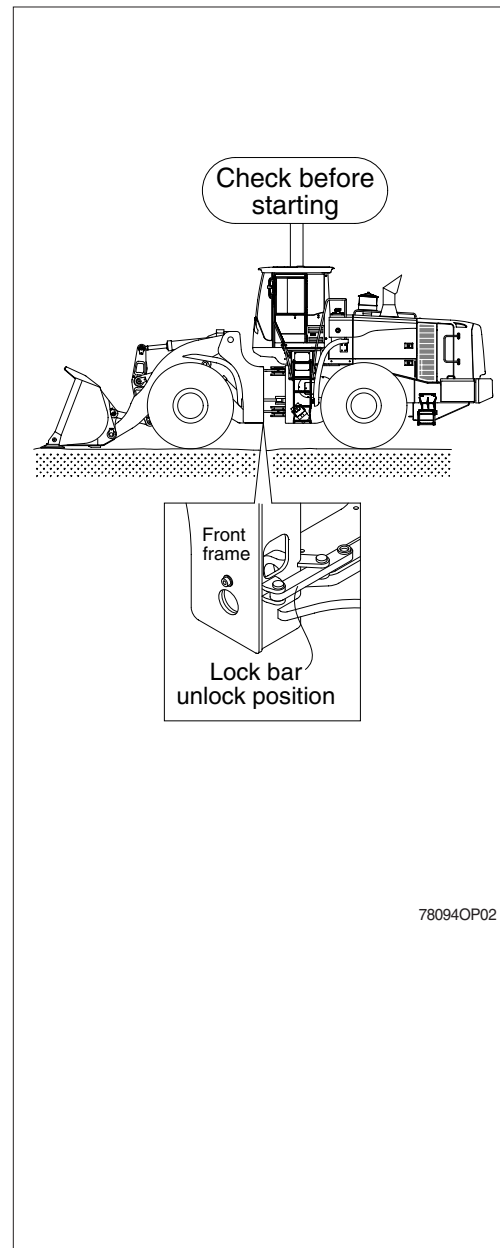

78094OP02