

# 3. CONTROL DEVICES

## 1. CAB DEVICES

1) The ergonomically designed console box and suspension type seat provide the operator with comfort.

### 2) ELECTRONIC MONITOR SYSTEM

(1) The centralized electronic monitor system allows the status and conditions of the machine to be monitored at a glance.

(2) It is equipped with a safety warning system for early detection of machine malfunction.

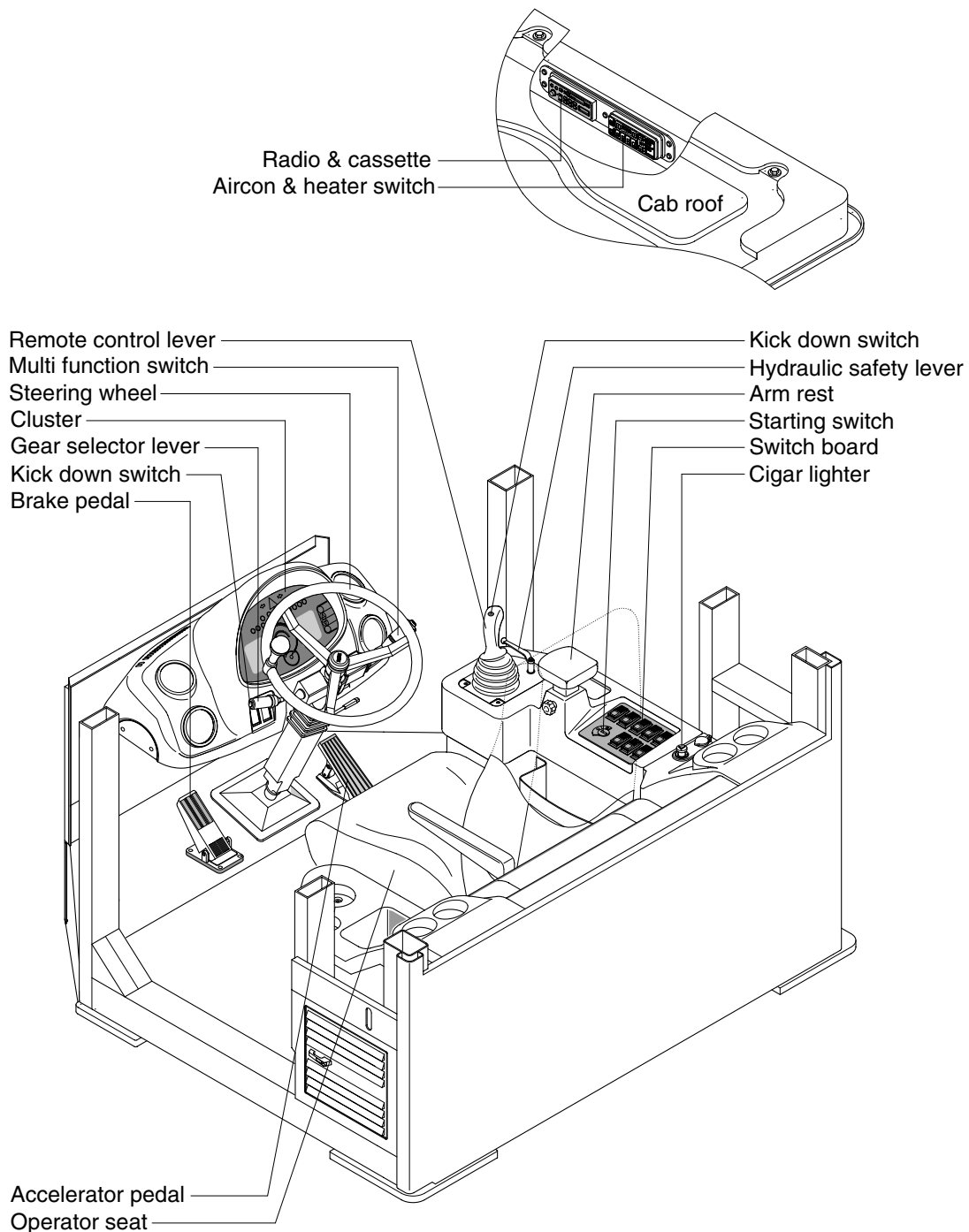

77073CD01