

# 2. SPECIFICATIONS

## 1. MAJOR COMPONENTS

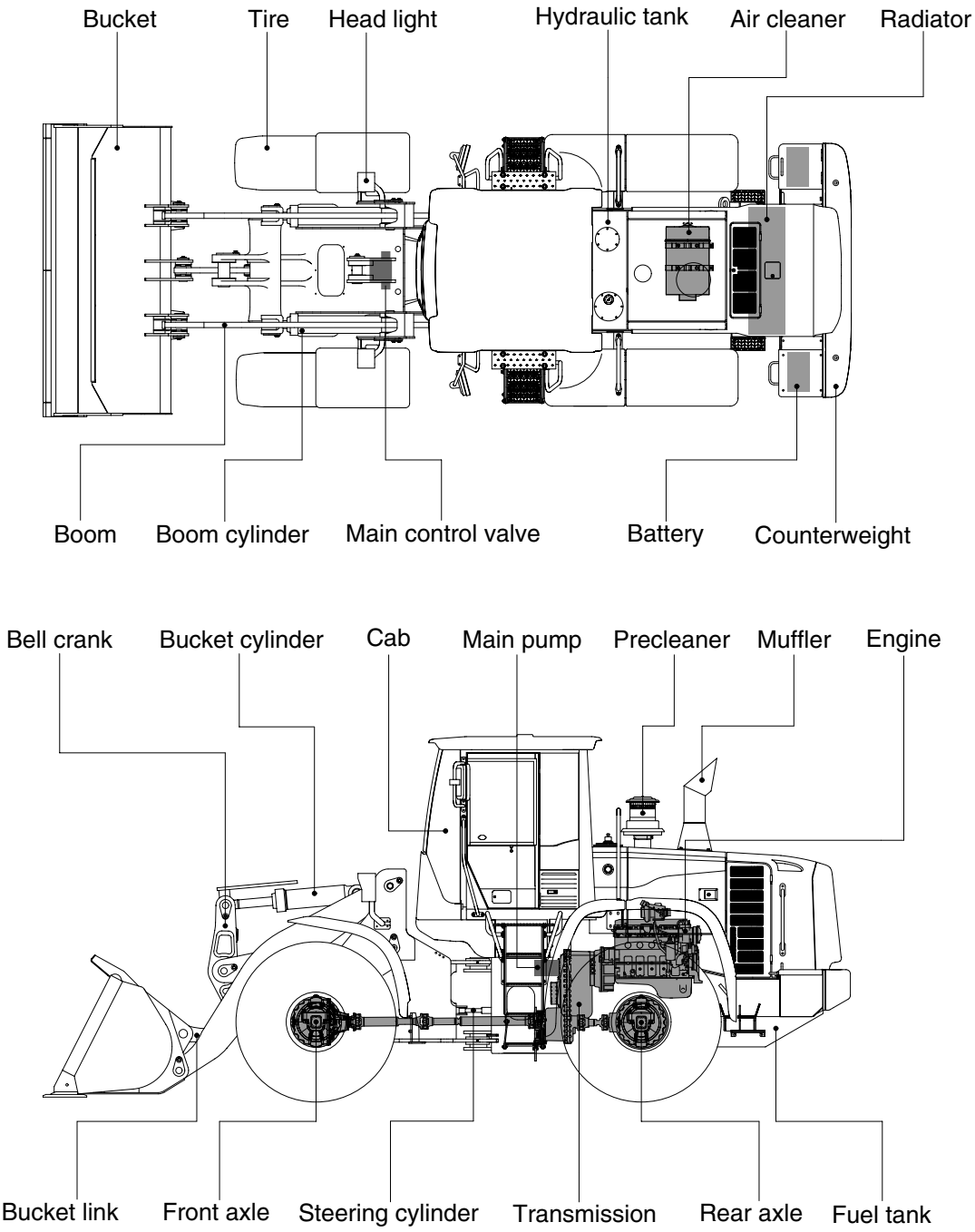

75792SE01