

5. AIR CONDITIONER AND HEATER

Air conditioner and heater are equipped for pleasant operation against outside temperature and defrost on window glass.

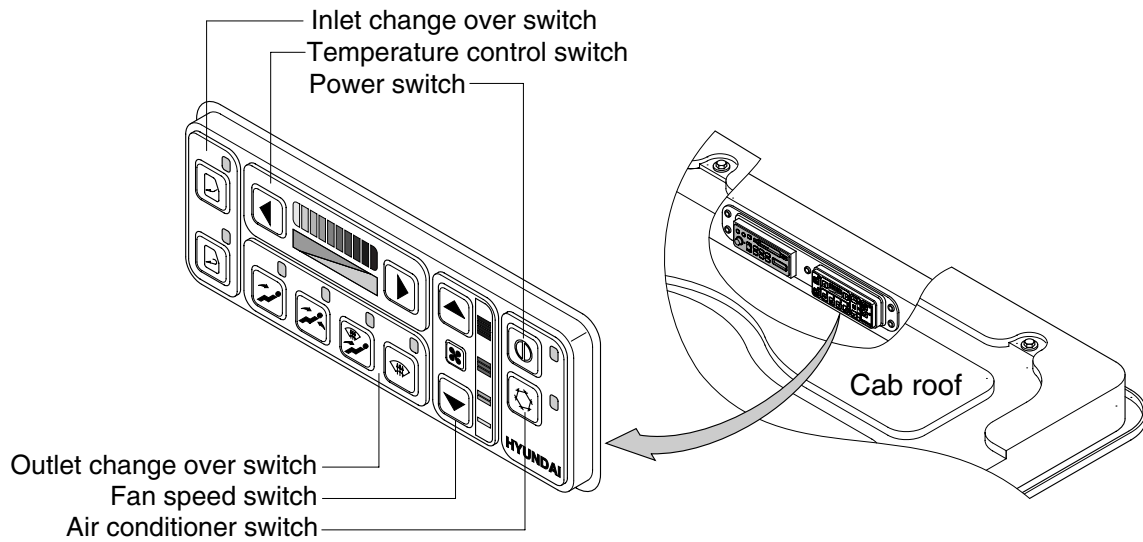

· Location of air outlet

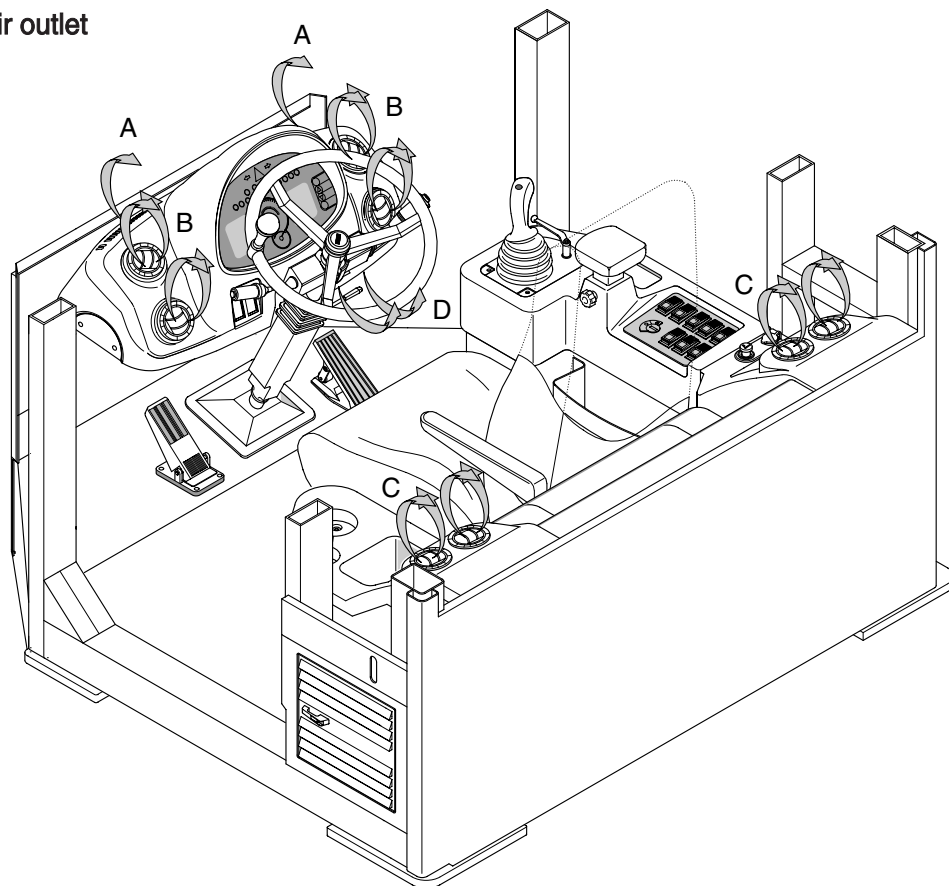

1) POWER SWITCH

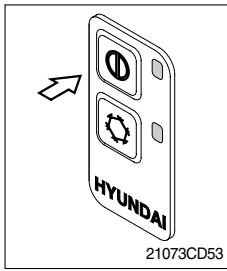

(1) This switch makes the system and the LED simultaneously ON or OFF.

(2) Default setting values

| Function | Air conditioner | Fan speed | Temperature | Outlet | Inlet |
|----------|-----------------|-----------|-------------|--------|---------------|
| Value | OFF | 1 | Max cool | Face | Recirculation |

2) AIR CONDITIONER SWITCH(Compressor switch)

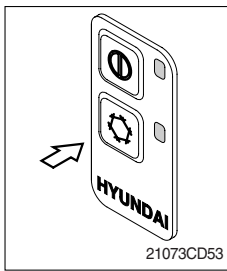

(1) Operating this switch turns the compressor and the LED simultaneously on or off.

(2) In accordance with the evaporator temperature, compressor turns on or off automatically without changing LED stare.

※ **Air conditioner operates to remove vapor and drains water through a drain hose. Water can be sprayed into the cab in case that the vacuum valve of drain hose has a problem. In this case, exchange the vacuum valve.**

3) FAN SPEED SWITCH

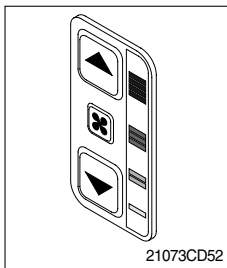

(1) It is possible to control the fan to four steps.

(2) The first step or the fourth step gives 5 times beeps.

4) TEMPERATURE CONTROL SWITCH

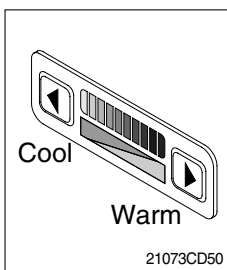

(1) There are 9 steps to control temperature from max cool to max warm controlled up and down by 1 step.

(2) Max cool and max warm arouse 5 times beeps.

(3) For the max warm or the max cool it's better to be configured as following table.

| Temperature | Air conditioner | Fan speed | Outlet | Inlet |
|-------------|-----------------|-----------|--------|---------------|
| Max cool | ON | 4 | Face | Recirculation |
| Max warm | OFF | 3 | Foot | Fresh |

5) OUTLET CHANGE OVER SWITCH

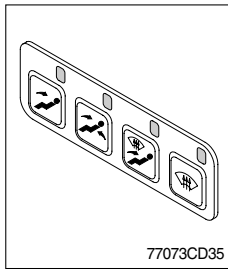

(1) There are four steps of air flow.

| Switch position | | Mode | | | |
|-----------------|---|------|---|---|---|
| | | | | | |
| Outlet | A | | | ● | ● |
| | B | ● | ● | ● | |
| | C | | ● | | ● |
| | D | ● | ● | ● | |

(2) When defroster switch operating, INLET switch turns to FRESH mode and air conditioner switch turns ON.

(3) In case of heating range(5~Max warm), air conditioner won't turns ON.

6) INLET CHANGE OVER SWITCH

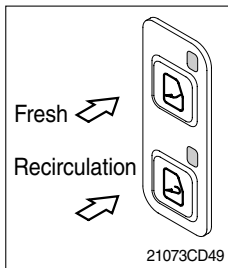

(1) It is possible to change the air-inlet method.

① Fresh

Inhaling air from the outside to pressurize cab inside.

※ **Check out the fresh air filter periodically to keep a good efficiency.**

② Recirculation

It recycles the heated or cooled air to increase the energy efficiency.

※ **Change air occasionally when using recirculation for a long time.**

※ **Check out the recirculation filter periodically to keep a good efficiency.**

(2) Recirculation function operates when the system is OFF but it can be changed whenever needed.