

7. ELECTRICAL SYSTEM

1) WIRING, GAUGES

Check regularly and repair loose or malfunctioning gauges when found.

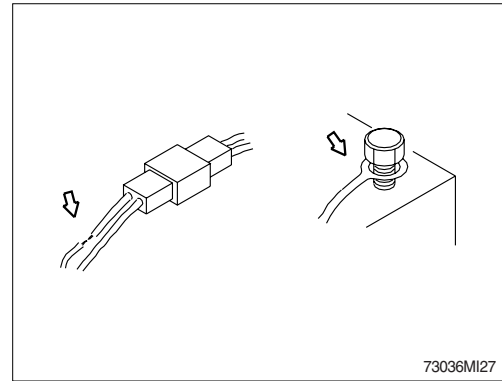

2) BATTERY

▲ When open the battery cover for servicing and checking the battery, be careful not to be injured by falling of the cover.

(1) Check and repair

- ① Check the electrolyte level and fill with distilled water to the prescribed level as necessary.
- ② Wash the terminal with hot water if it is contaminated, and apply grease to the terminals after washing.

▲ Do not stain clothes or skin with electrolyte as it is acid.

Be careful not to get the electrolyte in eyes.

Wash with clean water and go to the doctor if it enters the eyes.

※ Remove the fire and spark around battery.

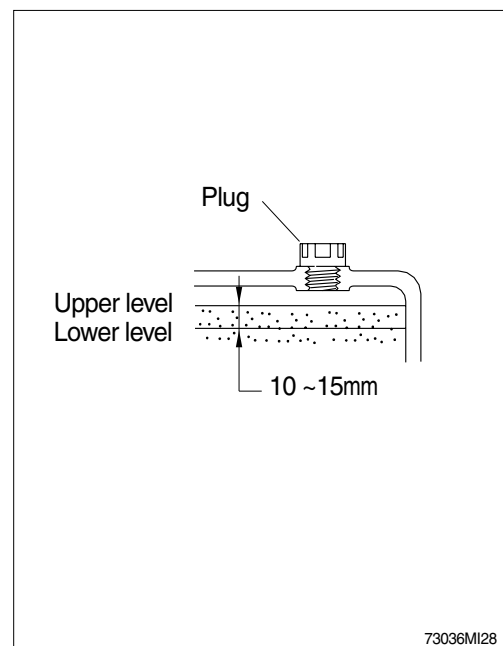

(2) Specific gravity of battery

Judge the charging rate of battery by the specific gravity. The specific gravity changes by the ambient temperature.

Check the charging rate by referring to the chart below.

Temperature Charging rate	20°C	10°C	-10°C
	100%	1.26	1.27
90%	1.24	1.25	1.26
80%	1.22	1.23	1.24
75%	1.21	1.22	1.23

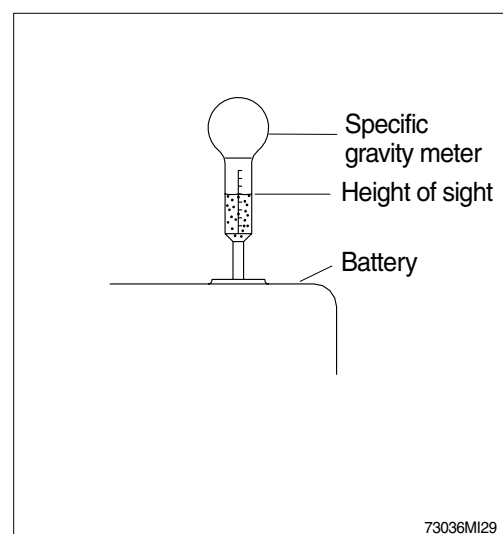

(3) Method of removing the battery cable

Remove the cable from the ground connection first(⊖ terminal side) and reconnect it last reassembling.

※ Pay attention to the correct polarity.

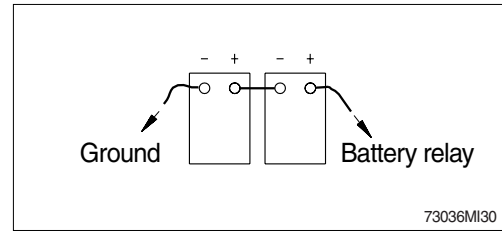

3) STARTING THE ENGINE WITH A BOOSTER CABLE

Keep following order when you are going to start engine using booster cable.

(1) Connection of booster cable

※ Use the same capacity of battery for starting

- ① Connect the red terminal of booster cable to the battery(+) terminal between exhausted and new battery.
- ② Connect the black terminal of the booster cable to the battery(-) terminal between exhausted and new battery.

※ Keep firmly all connection, the spark will be caused when connecting finally.

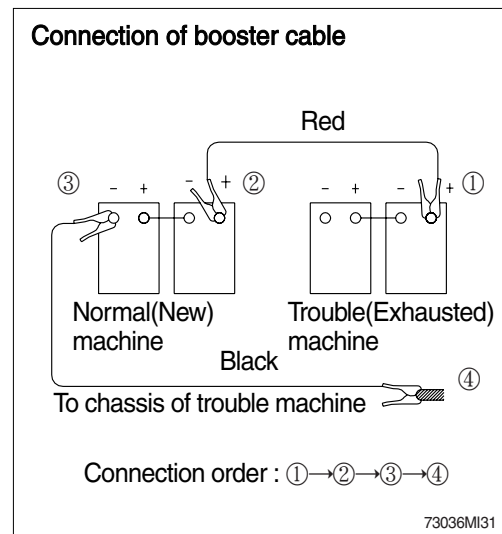

(2) Starting the engine

- ① Start engine with starting key.
- ② If you can not start it by one time, restart the engine after 2 minutes.

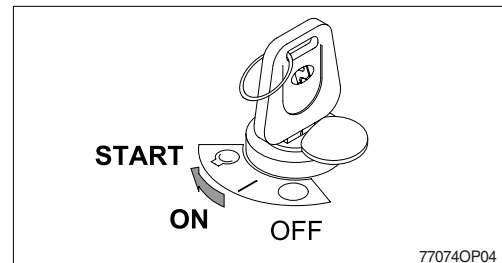

(3) Taking off the booster cable

- ① Take off the booster cable(Black).
- ② Take off the booster cable(Red) connected to the (+) terminal.
- ③ Run engine with high idle until charging the exhausted battery by alternator, fully.

▲ **Explosive gas is generated while using the battery or charging it. Keep away flame and be careful not to cause the spark.**

- ※ **Charge the battery in the well ventilated place.**
- ※ **Place the machine on the earth or concrete. Avoid to charge the machine on the steel plate.**
- ※ **Do not connect (+) terminal and (-) terminal when connecting booster cable because it will be shorted.**

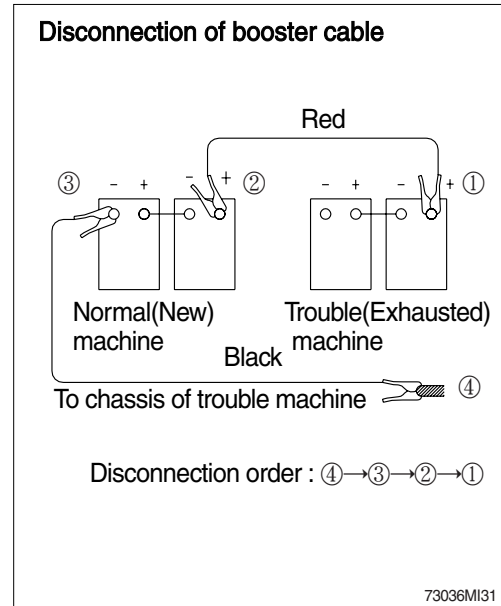

4) Welding repair

Before start to welding, follow the below procedure.

- (1) Shut off the engine and remove the starting switch.
- (2) Disconnect ground cable from battery by master switch.
- (3) Before carrying out any electric welding on the machine, the battery cables should be disconnected and the connectors pulled out of the electronic control units(MCU, TCU, ECM, cluster etc).
- (4) Connect the earth(ground) lead of the welding equipment as close to the welding points as possible.

- ※ **Do not weld or flame cut on pipes or tubes that contain flammable fluids. Clean them thoroughly with nonflammable solvent before welding or flame cutting on them.**

▲ **Do not attempt to welding work before carry out the above.**

If not, it will caused serious damage at electric system.

