

3. SWITCHES

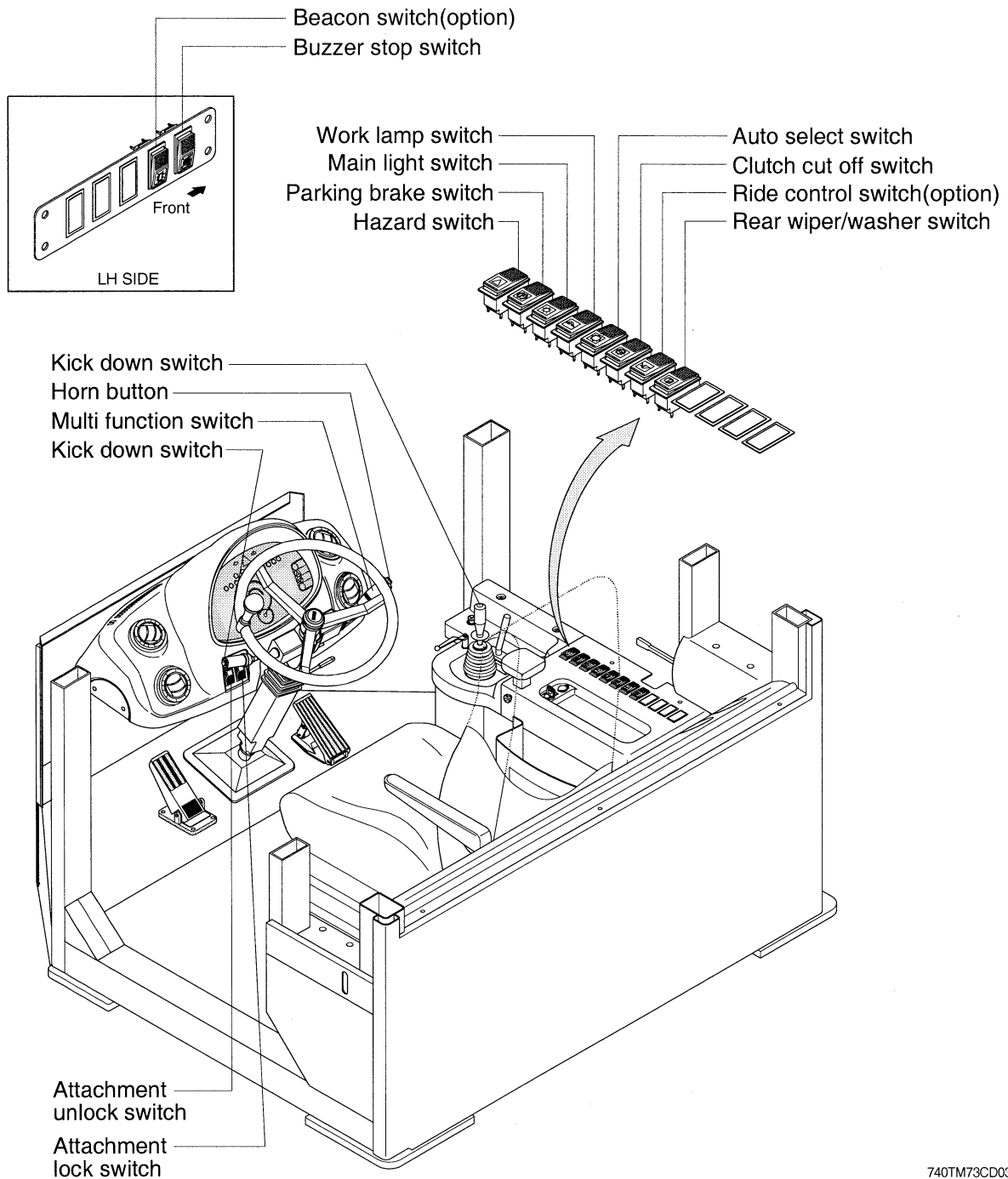

740TM73CD03

1) STARTING SWITCH

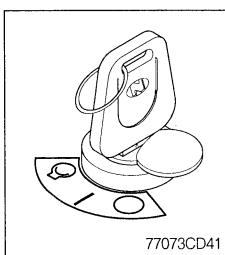

(1) There are three positions, OFF, ON and START.

- ○ (OFF) : None of electrical circuits activate.
- | (ON) : All the systems of machine operate.
- ◯ (START) : Use when starting the engine.

Release key immediately after starting.

※ **Key must be in the ON position with engine running maintain electrical and hydraulic function and prevent serious machine damage.**

2) HAZARD SWITCH

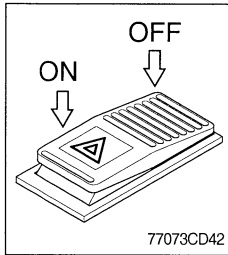

(1) Use for parking, or roading machine.

- ※ **If the switch is left ON for a long time, the battery may be discharged.**

3) CLUTCH CUT OFF SWITCH

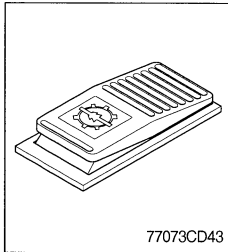

(1) This switch is pressed, it will cut off the clutch when brake operates.

- ※ **Be careful not to use this switch when driving on a slope.**
- (2) When the switch failure occurs, it will be able to operate a clutch off function from LCD.
- ※ **Refer to page 3-9.**

4) PARKING BRAKE SWITCH

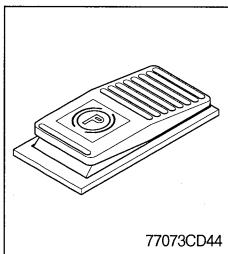

(1) This switch is pressed, the parking brake will start to operate and the gauge panel warning lamp will comes ON.

- ※ **When operating the gear selector lever, be sure to release the parking brake. If the machine is operated with the parking brake engaged, the brake will overheat and may cause the brake system to go out of order.**

5) MAIN LIGHT SWITCH

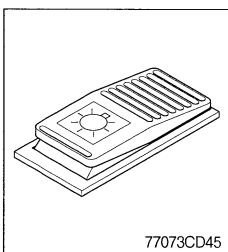

(1) This switch use to operates the clearance lamp and head light by two step.

- First step : Clearance lamp and cluster illumination lamp comes ON. Also, all indicator lamp of switches come ON.
- Second step : Head light comes ON.

6) WORK LAMP SWITCH

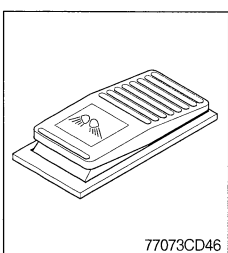

(1) This switch use to operates the front and rear work lamps by two step.

- First step : Front work lamp located on the cab comes ON.
- Second step : Rear work lamp located on the cab comes ON.

7) REAR WIPER AND WASHER SWITCH

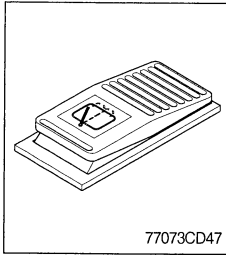

- (1) The switch use to operates the rear wiper and washer by two step.
- First step : The rear wiper operates.
 - Second step : The washer liquid is sprayed and the rear wiper is operated only while pressing. If release the switch, return to the first step position.

8) BUZZER STOP SWITCH

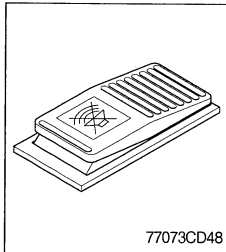

- (1) The red lamp on the cluster lights ON and the buzzer sounds when the machine has a problem.
In this case, if the switch is pressed, the buzzer will be stopped. Be sure to check machine for problems.
- (2) Wait until the lamp is turned OFF, if the red lamp lights ON after the buzzer stopped.
If not, stop engine and check the system which the lamp is ON.

9) AUTO SELECT SWITCH

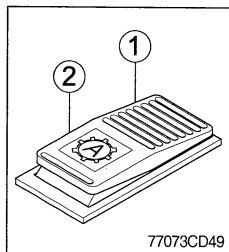

(1) Manual mode(①)

Press the top of the switch for the manual mode of the autoshift function. The operator selects the desired speed and the desired direction in the manual mode with the gear selector lever.

(2) Automatic mode(②)

Press the bottom of the switch for the autoshift function in the automatic mode. Press the bottom of the switch prior to shifting the transmission into forward or reverse in order to activate the autoshift function.

※ The operator can select two kinds of auto matic modes.

(1st ↔ 4th, 2nd ↔ 4th)

※ When the switch failure occurs, it will be able to operate a auto select function from LCD.

※ Refer to page 3-9.

10) BEACON SWITCH (Option)

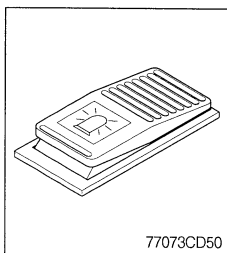

- (1) This switch turns ON the rotary light on the cab.

11) RIDE CONTROL SWITCH (Option)

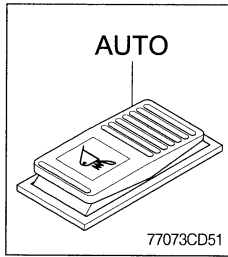

(1) AUTO position

Push in the top of the ride control switch in order to turn on the automatic ride control. The automatic ride control automatically turns on when the travel speed exceeds a preset speed of approximately 9.5km/h. The automatic ride control automatically shuts off during low speed 8km/h travel mode.

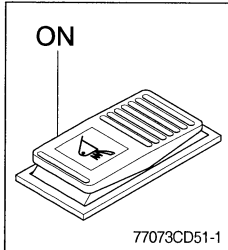

(2) ON position

Push in the bottom of the ride control switch in order to turn on the system for ride control regardless speed. The ride control will smooth the ride of the machine during travel.

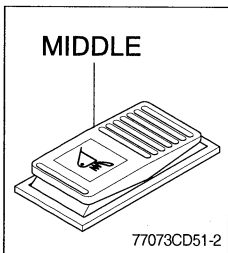

(3) MIDDLE position

Push the ride control switch to the middle position in order to turn off the system for the ride control.

12) ATTACHMENT LOCK SWITCH

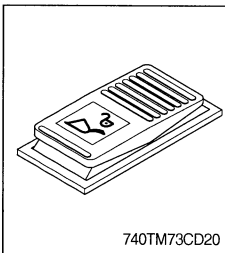

(1) This switch is use to engage the quick coupler pins.

(2) If this switch is pressed for 5 seconds, the quick coupler pins move in the engaged position.
If the switch is released, the quick coupler pins will remain in the engaged position.

※ Check for engagement as followings.

- ① Put down pressure on the attachment.
- ② Back up the machine and make sure that there is no movement between the quick coupler and attachment.

13) ATTACHMENT UNLOCK SWITCH

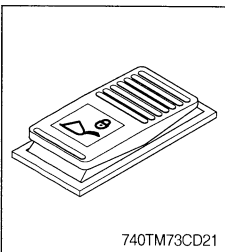

(1) This switch is use to disengage the quick coupler pins.

(2) If this switch is pressed for 5 seconds, the quick coupler pins move in the disengaged position.
If the switch is released, the quick coupler pins will remain in the disengaged position.

14) HORN BUTTON

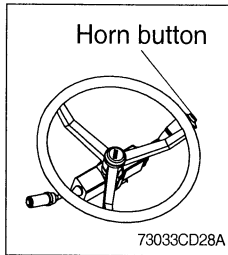

- (1) If you press the button on the top of the multifunction switch, the horn will sound.

15) CAB LAMP SWITCH

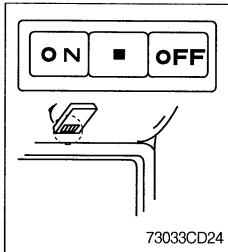

- (1) This switch turns ON the cab room lamp.

16) KICK DOWN SWITCH

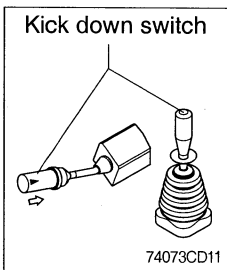

(1) Manual mode

It is effective 2nd speed to 1st speed only and recover to 2nd speed quickly when push the switch one more time.

(2) Automatic mode

① Mode 1(Down/Up)

It shifts down quickly from current gear to one step lower speed by pushing the switch and recover to original speed quickly when push the switch one more time.

② Mode 2(Down)

It shifts down from current gear to one step lower speed when push the switch everytime.

Refer to page 3-9.

17) MULTI FUNCTION SWITCH

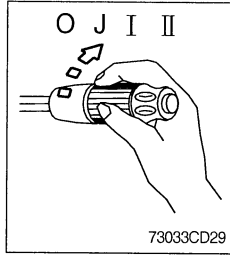

(1) Front wiper and washer switch

- ① When the switch is in **J** position, the wiper moves intermittently.
- ② When placed in **I** or **II** position, the wiper moves continuously.
- ③ If you press a button at the end of the lever, washer liquid will be sprayed and the wiper will be activated 2-3 times.

※ **Check the quantity of washer liquid in the tank. If the level of the washer liquid is LOW, add the washer liquid (In cold, winter days) or water. The capacity of the tank is 1 liter.**

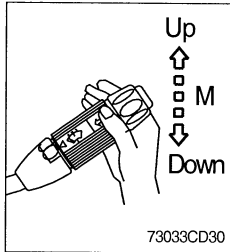

(2) Dimmer switch

- ① This switch is used to turn the head lights direction.
- ② Switch positions
 - Up : To flash for passing
 - Middle : Head lights low beam ON
 - Down : Head lights high beam ON
- ③ If you release the switch when it's in up position, the switch will return to middle.

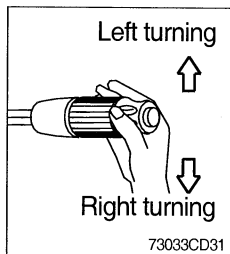

(3) Turning switch

- ① This switch is used to warn or signal the turning direction of the machine to other vehicles or equipment.
- ② Push the lever up for turning left, pull the lever down for turning right.