

2. SPECIFICATIONS

1. MAJOR COMPONENTS

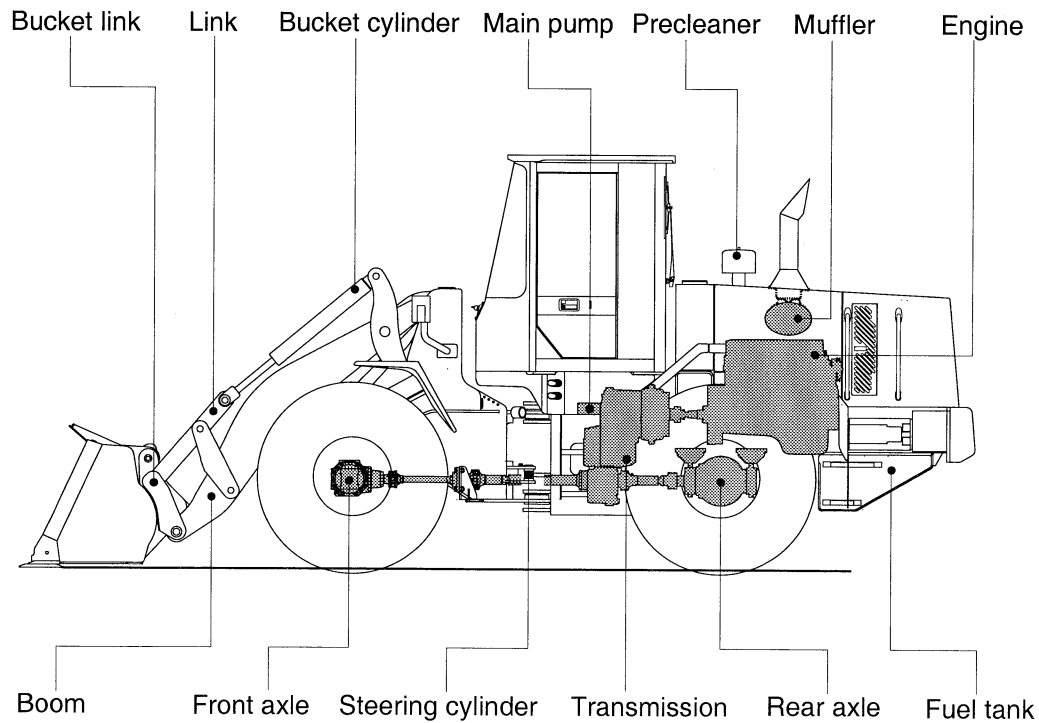
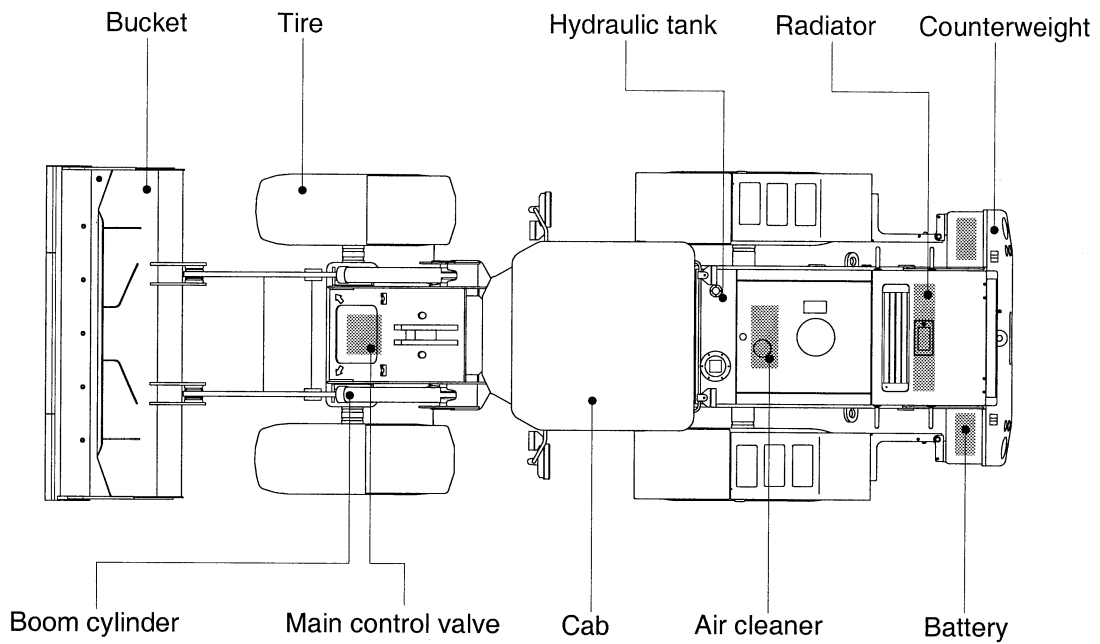

740TM72SP01