

2. SPECIFICATIONS

1. MAJOR COMPONENTS

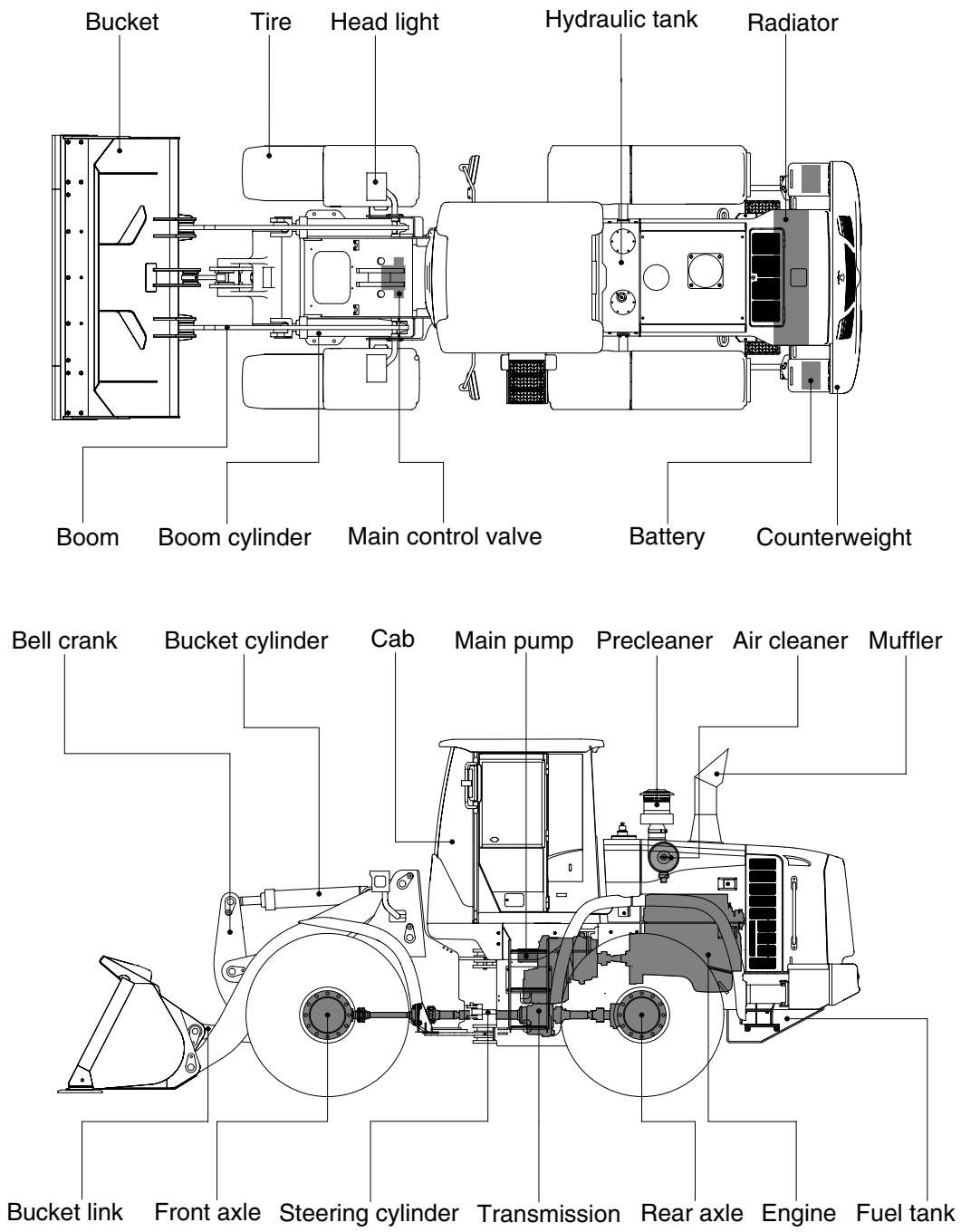

74092SP05