

## EC Declaration of conformity - update 04/01/'10

1. We hereby declare that the following machine comply with the machine directive 2006/42/EC, EMC-directive 2004/108/EC, Non-road mobile machinery emission directive 97/68/EC (amended by 2002/88/EC, 2004/26/EC, 2006/105/EC) and noise emission 2000/14/EC (amended by 2005/88/EC).

Wheel loader	Model :	*****
	Serial Nr. :	***

2. Manufacturer  
 Hyundai Heavy Industries Co. Ltd.  
 1 Chonha-Dong, Dong-Ku  
 Ulsan  
 The republic of Korea

Authorized representative : Owner of the technical file for machine production. (TCF : Technical Construction File)	Hyundai Heavy Industries Europe N.V. Vossendal 11 2440 Geel Belgium
--	--

3. Harmonized European directives : EN 474-1:2006, EN 474-3:2006, EN ISO 2867:2008, ISO 7096 : 2000, EN ISO 6682:2008, ISO 6683:2008, EN ISO 2860:2008, EN ISO 3450:2008, EN ISO 3457:2003, ISO 5006:2006

4. Noise level :

Certain n° :	e13*2000/14*2005/88*0059*08
Date :	2009-06-17
Conformity assessment procedure :	Attachment VIII following the periodical inspection on technical extended with "Information on the scope of delivery" by TÜV Rheinland.
Authorized entity :	Société Nationale de Certification et d'Homologation s.à r.l CE0499 11, route de Luxembourg 5230 Sandweiler Luxemburg
Engine power :	*** kW
Guaranteed sound power level :	*** dB (A)

5. Remarks

\*\*\*\*\*

Managing Director

Geel, Belgium

\*\*/\*\*/\*\*\*\*

## FOREWORD

This manual contains a number of instructions and safety recommendations regarding driving, handling, lubrication, maintenance, inspection and adjustment of the wheel loader.

The manual is to promote safety maintenance and enhance machine performance.

Keep this manual handy and have all personnel read it periodically.

If you sell the machine, be sure to give this manual to the new owners.

This machine complies with EC directive "2006/42/EC".

### 1. Read and understand this manual before operating the machine.

This operator's manual may contain attachments and optional equipment that are not available in your area. Please consult your local Hyundai distributor for those items you require.

Improper operation and maintenance of this machine can be hazardous and could result in serious injury or death.

Some actions involved in operation and maintenance of the machine can cause a serious accident, if they are not done in a manner described in this manual.

The procedures and precautions given in this manual apply only to intended uses of the machine.

If you use your machine for any unintended uses that are not specifically prohibited, you must be sure that it is safe for you and others. In no event should you or others engage in prohibited uses of actions as described in this manual.

### 2. Inspect the jobsite and follow the safety recommendations in the safety hints section before operating the machine.

### 3. Use genuine Hyundai spare parts for the replacement of parts.

We expressly point out that Hyundai will not accept any responsibility for defects resulting from non-genuine parts or non workmanlike repair.

In such cases Hyundai cannot assume liability for any damage.

Continuing improvements in the design of this machine can lead to changes in detail which may not be reflected in this manual. Consult Hyundai or your Hyundai distributor for the latest available information for your machine or for questions regarding information in this manual.

## BEFORE SERVICING THIS MACHINE

It is the responsibility of the owner and all service and maintenance personnel to avoid accidents and serious injury by keeping this machine properly maintained.

It also is the responsibility of the owner and all service and maintenance personnel to avoid accidents and serious injury while servicing the machine.

No one should service or attempt to repair this machine without proper training and supervision.

All service and maintenance personnel should be thoroughly familiar with the procedures and precautions contained in this manual.

All personnel also must be aware of any federal, state, provincial or local laws or regulations covering the use and service of construction equipment.

The procedures in this manual do not supersede any requirements imposed by federal, state, provincial or local laws.

Hyundai can not anticipate every possible circumstance or environment in which this machine may be used and serviced.

All personnel must remain alert to potential hazards.

Work within your level of training and skill.

Ask your supervisor if you are uncertain about a particular task. Do not try to do too much too fast.

Use your common sense.

### ※ How to adjust the language of monitor

User can select preferable language and all displays are changed the selected language.

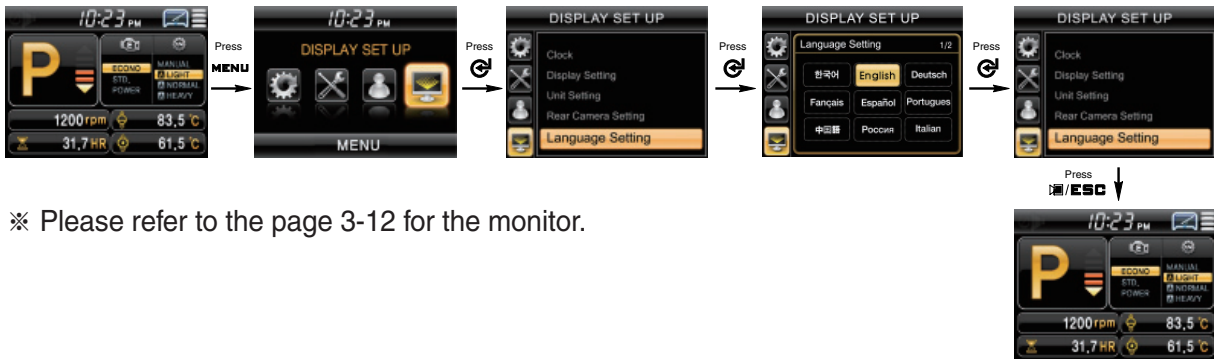

※ Please refer to the page 3-12 for the monitor.

**TABLE TO ENTER SERIAL NO. AND DISTRIBUTOR**

Machine Serial No.	
Engine Serial No.	
Manufacturing year	
Manufacturer Address	Hyundai Heavy Industries co., Ltd. 1, Jeonha-Dong, Dong-Ku, Ulsan 682-792, Korea
Distributor for Europe Address	Hyundai Heavy Industries Europe N. V. Vossendal 11 2240 Geel Belgium
Dealer Address	

## EC REGULATION APPROVED

- Noise level (EN474-1 : 2006 and 2000/14/EC) are as followings.  
LWA : 104 dB (EU only)  
LPA : 71 dB
- The value of vibrations transmitted by the operator's seat are lower than standard value of (EN474-1 : 2006 and 2002/44/EC)

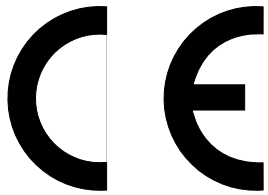

# SAFETY LABELS

## 1. LOCATION

Always keep these labels clean. If they are lost or damaged, attach them again or replace them with a new label.

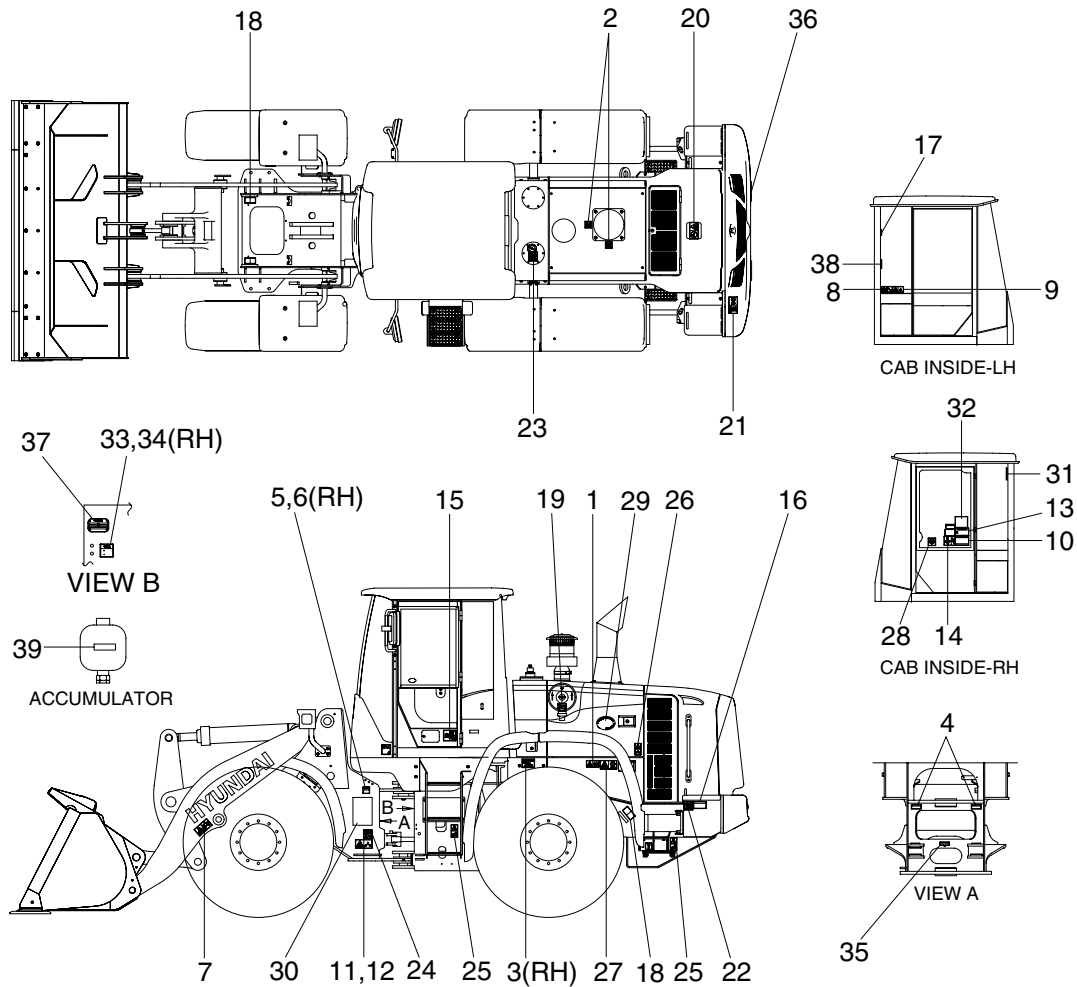

74090FW03

- |    |                       |    |                        |    |                      |
|----|-----------------------|----|------------------------|----|----------------------|
| 1  | Start motor           | 14 | Control ideogram       | 27 | Shearing-Engine hood |
| 2  | Turbocharger cover    | 15 | Air conditioner filter | 28 | Alternate exit       |
| 3  | Hyd oil level         | 16 | ECU connector          | 29 | Low emission engine  |
| 4  | Ride control (option) | 17 | Hammer                 | 30 | Service instruction  |
| 5  | Grease (A)            | 18 | Lift & tie             | 31 | Fire extinguisher    |
| 6  | Grease (B)            | 19 | Air cleaner            | 32 | Start procedure      |
| 7  | Bucket stopper        | 20 | Radiator cap           | 33 | Grease (C)           |
| 8  | Max h/reach           | 21 | Fueling                | 34 | Grease (D)           |
| 9  | Roll over             | 22 | Battery accident       | 35 | Grease-center        |
| 10 | ROPS cab              | 23 | Hyd oil lub            | 36 | Keep clear/Reflect   |
| 11 | Steering warning-LH   | 24 | High pressure hose     | 37 | Name plate           |
| 12 | Steering warning-RH   | 25 | Falling                | 38 | ROPS plate           |
| 13 | Reference manual      | 26 | Stay fix               | 39 | Accumulator          |

## 2. DESCRIPTION

There are several specific warning labels on this machine please become familiarized with all warning labels.

Replace any safety label that is damaged, or missing.

### 1) START MOTOR (item 1)

This warning label is positioned on the left side of the engine side cover.

- ▲ Start the engine only from the operator's compartment. Never short across the starter terminals or across the batteries. Shorting could bypass the engine neutral start system. Shorting could also damage the electrical system.

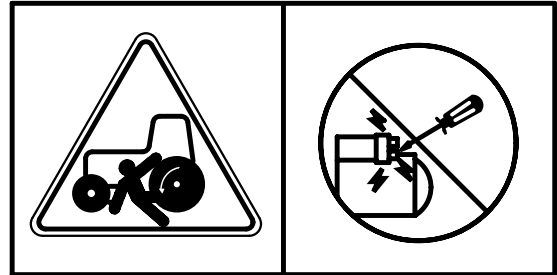

77070FW05

### 2) TURBOCHARGER COVER (item 2)

This warning label is positioned on the turbocharger cover.

- ▲ Do not touch turbocharger or it may cause severe burn.



21070FW02

### 3) HYDRAULIC OIL LEVEL (item 3)

This warning label is positioned on the left side of hydraulic oil tank.

- ▲ Place the bucket on the ground whenever servicing the hydraulic system.
- ※ Check oil level on the level gauge.
- ※ Refill the recommended hydraulic oil up to specified level if necessary.

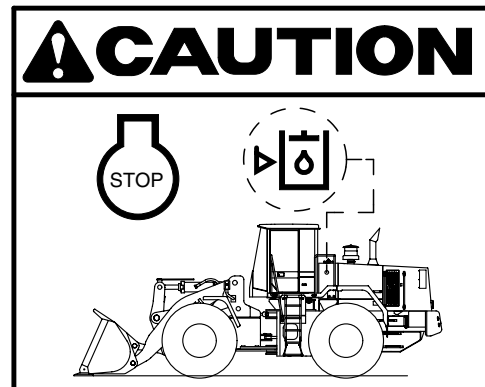

77070FW06

### 4) RIDE CONTROL (item 4)

This warning label is positioned on the front frame.

Before checking the boom operation system,

1. Bucket should be laid on the ground.
2. Turn out the drain screw in ride control valve to release the charged oil in accumulators.

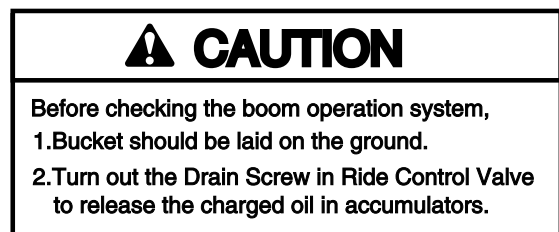

7707A0FW06

5) **BUCKET STOPPER** (Item 7)

This warning label is positioned on the middle of the boom.

- ▲ When working under or around the bucket or linkage, with bucket raised, proper support must be provided for the bucket and/or the linkage.

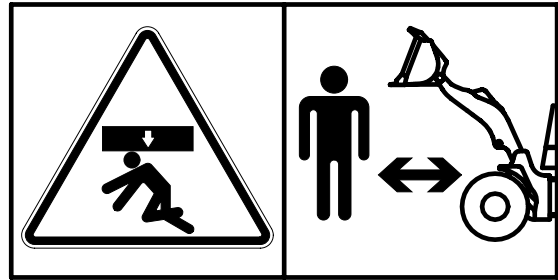

7803AFW05

6) **MAX HEIGHT** (item 8)

This warning label is positioned on the left side window of the cab.

- ▲ Serious injury or death can result from contact with electric lines. An electric shock being received by merely coming into the vicinity of an electric lines, the minimum distance should be kept considering the supply voltage as page 1-6.

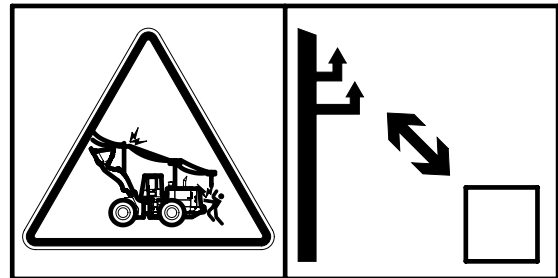

7803AFW16

7) **ROLL OVER** (item 9)

This warning label is positioned on the left side window of the cab.

- ▲ Structural damage, an overturn, modification, alternation, or improper repair can impair this structure's protection capability thereby voiding this certification.
- ▲ Always use seat belt when operating your machine. Always check the condition of the seat belt and the condition of the mounting hardware before you operate the machine.

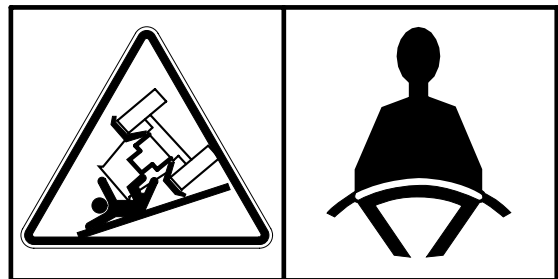

77070FW14

### 8) STEERING WARNING (item 11, 12)

The warning label is positioned on the side of the front frame.

- ▲ No clearance for person in this area when machine turns.
- ▲ Severe injury or death from crushing could occur.

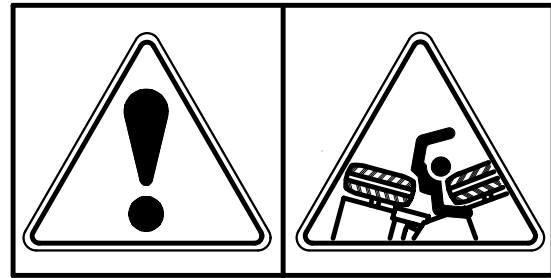

77070FW07

### 9) REFERENCE MANUAL (item 13)

This warning label is positioned on the right side window of the cab.

- ▲ Study the operator's manual before starting and operating machine.

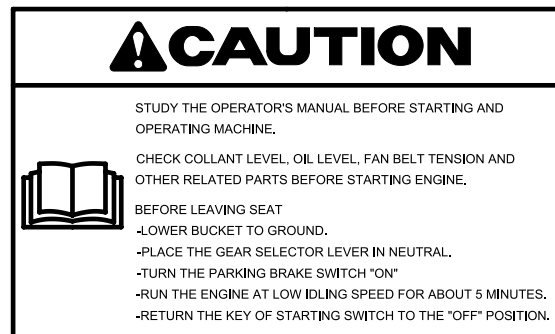

77070FW08

### 10) CONTROL IDEOGRAM (item 14)

This warning label is positioned on the right side window of the cab.

- ▲ Confirm the operation of control lever and working device before operating the machine.

※ Refer to the page 4-9 for details.

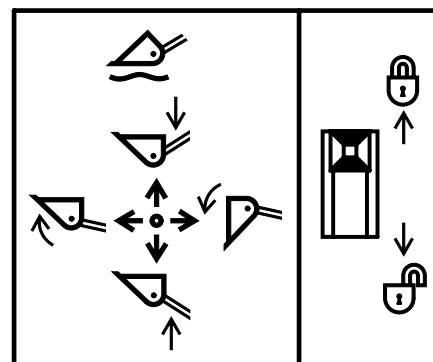

74090FW04

### 11) AIR CONDITIONER FILTER (item 15)

This warning label is positioned on the washer tank cover.

- ※ Periodic and proper inspection, cleaning and change of filter prolong air conditioner life time and maintain good performance.

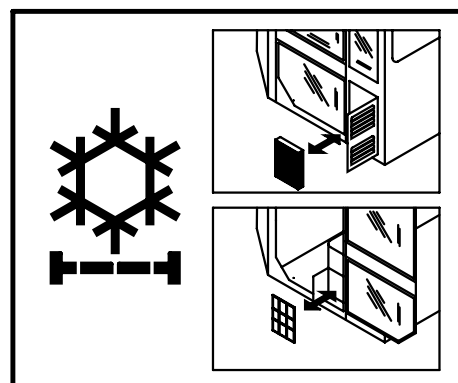

77070FW10

### 12) ECU CONNECTOR (item 16)

This warning label is positioned on the side of the battery box.

#### ⚠ Before carrying out any electric welding on this machine

- Pull the connectors out of all electronic control units.
- Connect the ground lead of the welding equipment as close to the welding point as possible.

※ Refer to the page 6-44 for details.

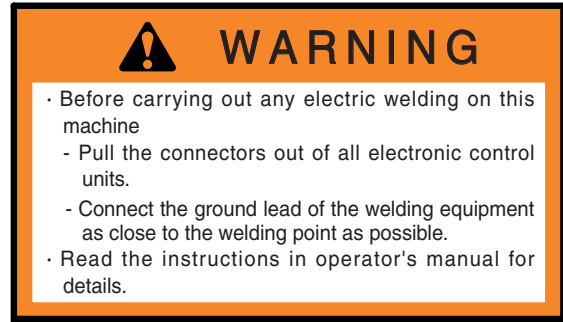

7803AFW20

### 13) LIFT & TIE (item 18)

This label is positioned on the both side of the front and rear frame.

#### - Lifting point

In order to lift the machine, attach the lifting devices to the lifting points.

#### - Tying point

In order to tie down the machine, attach the tie-downs to the tying points.

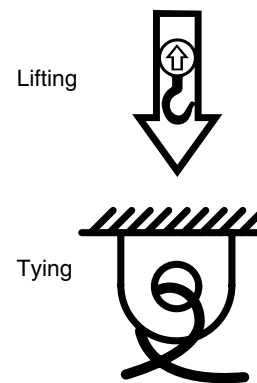

75790FW04

### 14) AIR CLEANER (item 19)

The warning label is positioned on the air cleaner.

#### ⚠ Periodic and proper inspection, cleaning and change of elements prolong engine life time and maintain the good performance of engine.

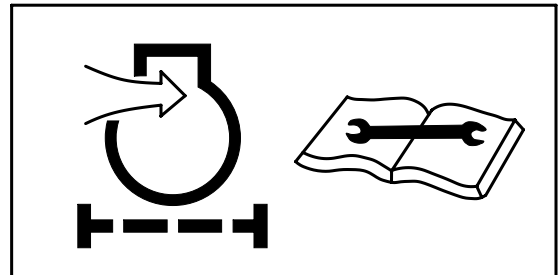

21070FW01

### 15) RADIATOR CAP (item 20)

This warning label is positioned on the radiator cover.

#### ⚠ Never open the filler cap while engine running or at high coolant temperature.



77070FW11

**16) FUELING** (item 21)

This warning label is positioned on the left side of fuel filler neck.

- ▲ Stop the engine when refueling. All lights or flames shall be kept at a safe distance while refueling.

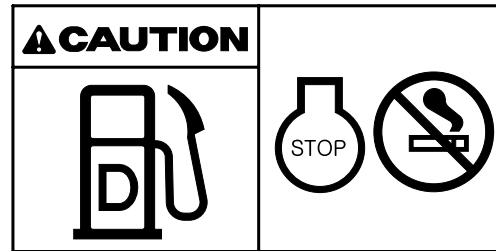

21070FW04

**17) BATTERY ACCIDENT** (item 22)

This warning label is positioned on the battery box.

- ▲ Electrolyte containing sulfuric acid cause severe burns. Avoid being in contact with skin, eyes or clothes. In the event of accident flush with sufficient water, call a physician immediately.
- ※ Maintain the electrolyte at the recommended level. Add distilled water to the battery only when starting up, never when shutting down. With electrolyte at proper level, less space may cause the gases to be accumulated in the battery.



7577A0FW05

**18) HYDRAULIC OIL LUB** (item 23)

This warning label is positioned on the top of the hydraulic oil tank.

- ※ Do not mix with different brand oils.
- ▲ Never open the filler cap while engine running or at high coolant temperature.
- ▲ Loosen the cap slowly and release internal pressure completely.



14070FW08

**19) STAY FIX (item 26)**

The warning label is positioned on the engine side door.

- ▲ Be sure to support the stay when the door needs to be opened.
- ▲ Be careful that the opened door may be closed by the external or natural force like strong wind.

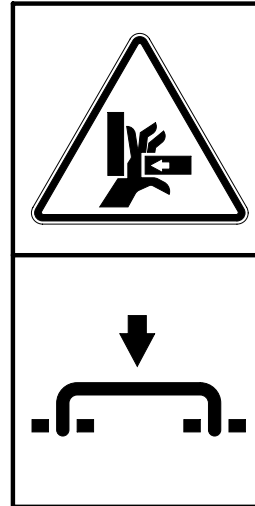

21070FW14

**20) SHEARING-ENGINE DOOR (item 27)**

This warning label is positioned on the left side of the engine side cover.

- ▲ Don't open the engine door during the engine's running.

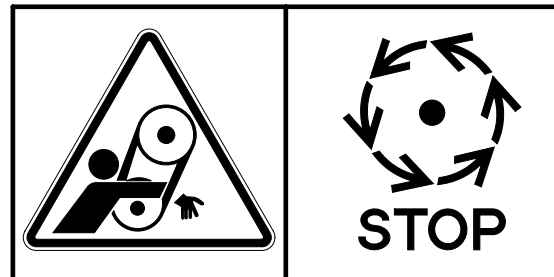

21070FW15

**21) ALTERNATE EXIT (item 28)**

This warning label is positioned on the right side window of the cab.

- ※ The right door serves us an alternate exit.

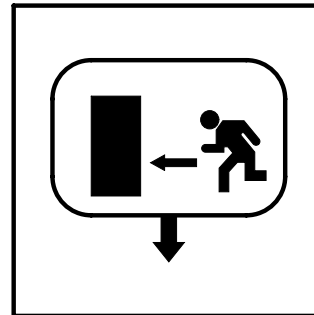

77070FW12

**22) START PROCEDURE (item 32)**

This warning label is positioned on the right side window of the cab.

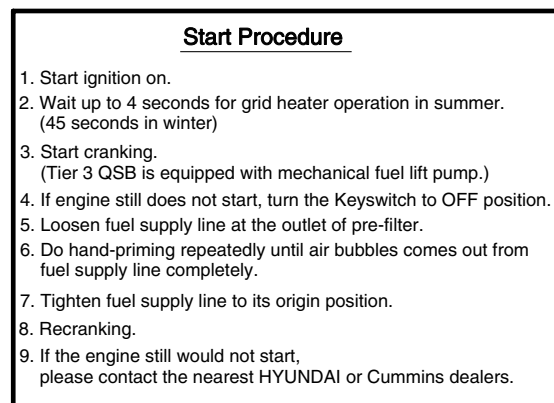

7607A0FW05

### 23) ACCUMULATOR (item 39)

This warning label is positioned on the accumulator of the solenoid valve.

- ※ The accumulator is filled with high-pressure nitrogen gas, and it is extremely dangerous if it is handled in the wrong way. Always observe the following precautions.

▲ Never make any hole in the accumulator expose it to flame or fire.

▲ Do not weld anything to the accumulator.

- ※ When carrying out disassembly or maintenance of the accumulator, or when disposing of the accumulator, it is necessary to release the gas from the accumulator. A special air bleed valve is necessary for this operation, so please contact your Hyundai distributor.

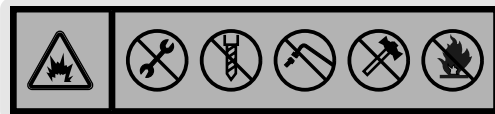

1107A0FW46

# MACHINE DATA PLATE

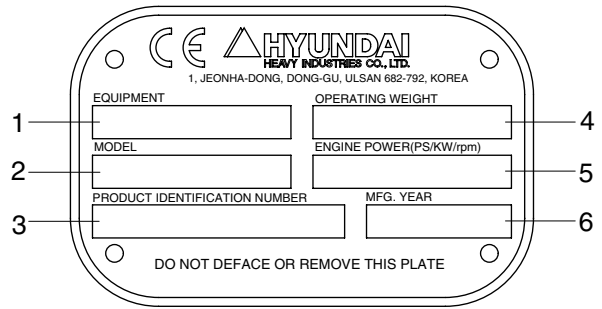
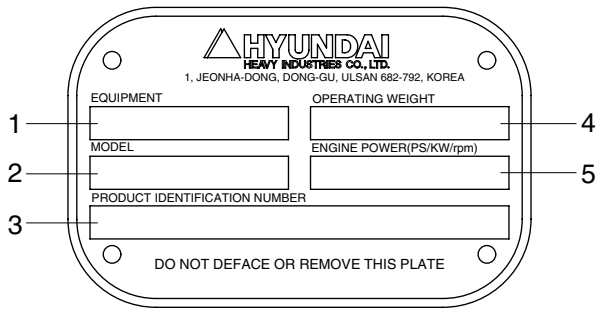

FOR EU ONLY

75790FW10

- |   |            |   |                               |   |                    |
|---|------------|---|-------------------------------|---|--------------------|
| 1 | Equipment  | 3 | Product identification number | 5 | Engine power       |
| 2 | Model name | 4 | Operating weight              | 6 | Manufacturing year |

※ The product identification number assigned to this particular machine and should be used when requesting information or ordering service parts for this machine from your authorized HYUNDAI dealer. The product identification number is also stamped on the frame.

## GUIDE

### 1. DIRECTION

The direction of this manual indicate forward, backward, right and left, when machine is on the traveling direction.

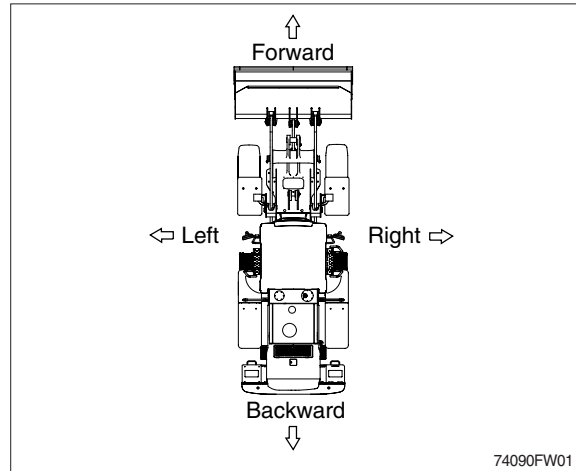

### 2. SERIAL NUMBER

Inform following when you order parts or the machine is out of order.

#### 1) MACHINE SERIAL NUMBER

The numbers are located on the left side of the rear frame.

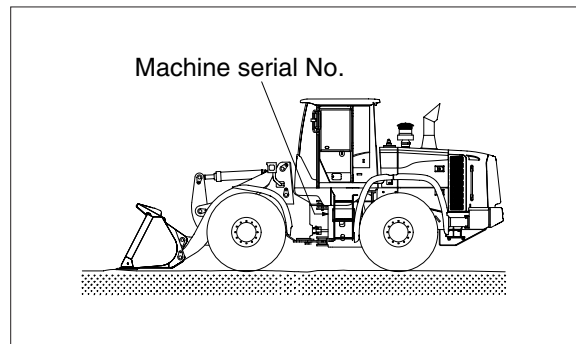

#### 2) ENGINE SERIAL NUMBER

The numbers are located on the engine name plate.

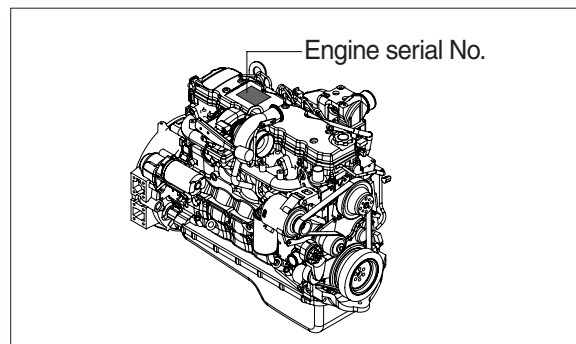

### 3. INTENDED USE

This machine is designed to be used mainly for the following work.

- Excavating work
- Leveling work
- Loading work
- Transporting work

※ Please refer to the section 4 (efficient working method) further details.

### 4. SYMBOLS

▲ Important safety hint.

△ It indicates matters which can cause the great loss on the machine or the surroundings.

※ It indicates the useful information for operator.