

6. TOWING THE MACHINE

⚠ Personal injury or death could result when towing a disabled machine incorrectly.

⚠ Block the machine to prevent movement before releasing the brakes. The machine can roll free if it is not blocked.

Except for an emergency, do not tow this machine. If it is inevitable to tow this machine, observe the following.

1) GENERAL

(1) Parking brake cylinder of the machine is operated by the spring force and released by hydraulic pressure.

If the engine does not operate, the brake will be operated to stop the machine.

(2) When the machine is towed move it for a repair to nearby place at the speed less than 2km/hr(1.2mph). Transport it on a trailer, if it has to be moved for a long distance.

(3) When the steering device and the brake of the machine to be towed can not be operated, transport by trailer.

⚠ Be careful when towing.

⚠ Be careful that the brake will not work if there is any disorder in the braking system.

(4) When you tow the machine from the front, attach the tow line to the tow eyes on the front frame(1). When you tow the machine from the rear, attach the tow line to the towing pin(2).

(5) Do not use a chain for pulling a disabled machine. A chain link can break. This may cause personal injury. Use a wire rope cable with ends that have loops or rings. Place an observer in a safe position in order to watch the pulling procedure. The observer can stop the procedure, if necessary. The procedure should be stopped if the cable starts to break. Also, stop the procedure if the cable starts to unravel. Stop pulling whenever the towing machine moves without moving the towed machine.

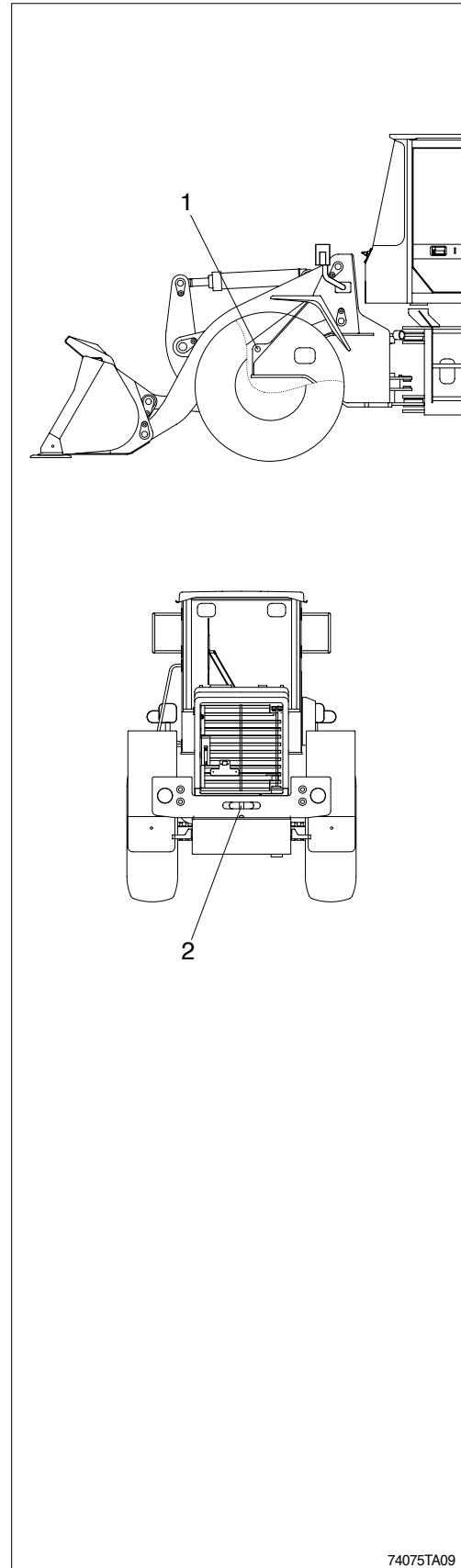

74075TA09

- (6) Keep the tow line angle to a minimum. Do not exceed a 30 degree angle from the straight ahead position.
- (7) Quick machine movement could overload the tow line or the tow bar. This could cause the tow line or the tow bar to break. Gradual, steady machine movement will be more effective.
- (8) Normally, the towing machine should be as large as the disabled machine. Make sure that the towing machine has enough brake capacity, enough weight, and enough power. The towing machine must be able to control both machines for the grade that is involved and for the distance that is involved.
- (9) You must provide sufficient control and sufficient braking when you are moving a disabled machine downhill. This may require a larger towing machine or additional machines that are connected to the rear of the disabled machine. This will prevent the machine from rolling away out of control.
- (10) All situation requirements cannot be listed. Minimal towing machine capacity is required on smooth, level surfaces. On inclines or on surfaces in poor condition, maximum towing machine capacity is required.
- (11) When any towed machine is loaded, this machine must be equipped with a brake system that is operable from the operator compartment.

Consult your HYUNDAI dealer for the equipment that is necessary for towing a disabled machine.

2) WHEN THE ENGINE WORKS

- (1) When the transmission system or steering wheel is workable and the engine is running, **the machine can be towed only for a short distance.**
For example, pull the machine out of mud or pull the machine to side of the road.
- (2) The operator of the towed machine should turn the steering wheel into the direction in which the machine is towed.

3) WHEN THE ENGINE DOES NOT WORK

When towing the machine with the engine stopped, do it in the following order.

(1) Disconnect the front and rear drive shafts.

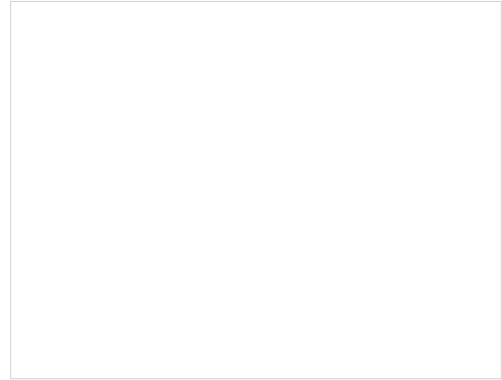

(2) Loosen the steering cylinder as the steering operation is not workable.

Even if the brake is in good condition, the machine has only wheel braking capability.

As the hydraulic booster is not working, more force is required when pressing the pedal.

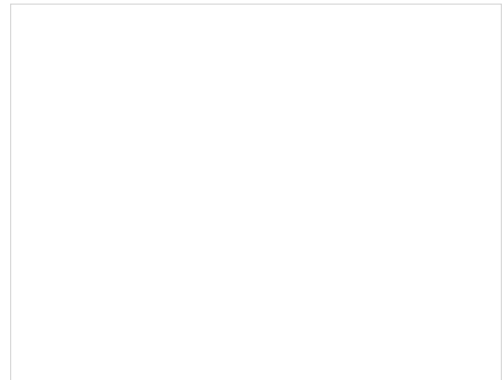

(3) The parking brake is activated by spring and released by hydraulic pressure. If the engine does not work, the brake will be activated, so release the parking brake; Adjust the bolts to unlock the safety brake less than 46mm and lock the counter nut.

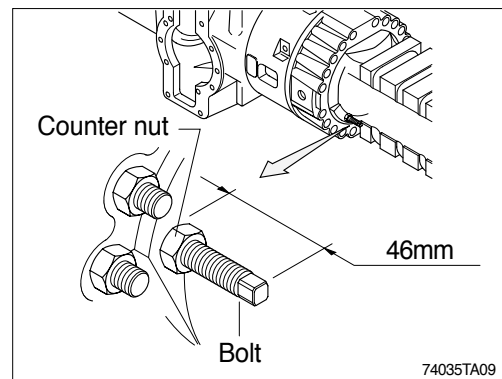

(4) Connect firmly between the traction machine and the towed machine.

Position each traction machine at the front and rear of the machine to be towed.

