

7. OTHERS

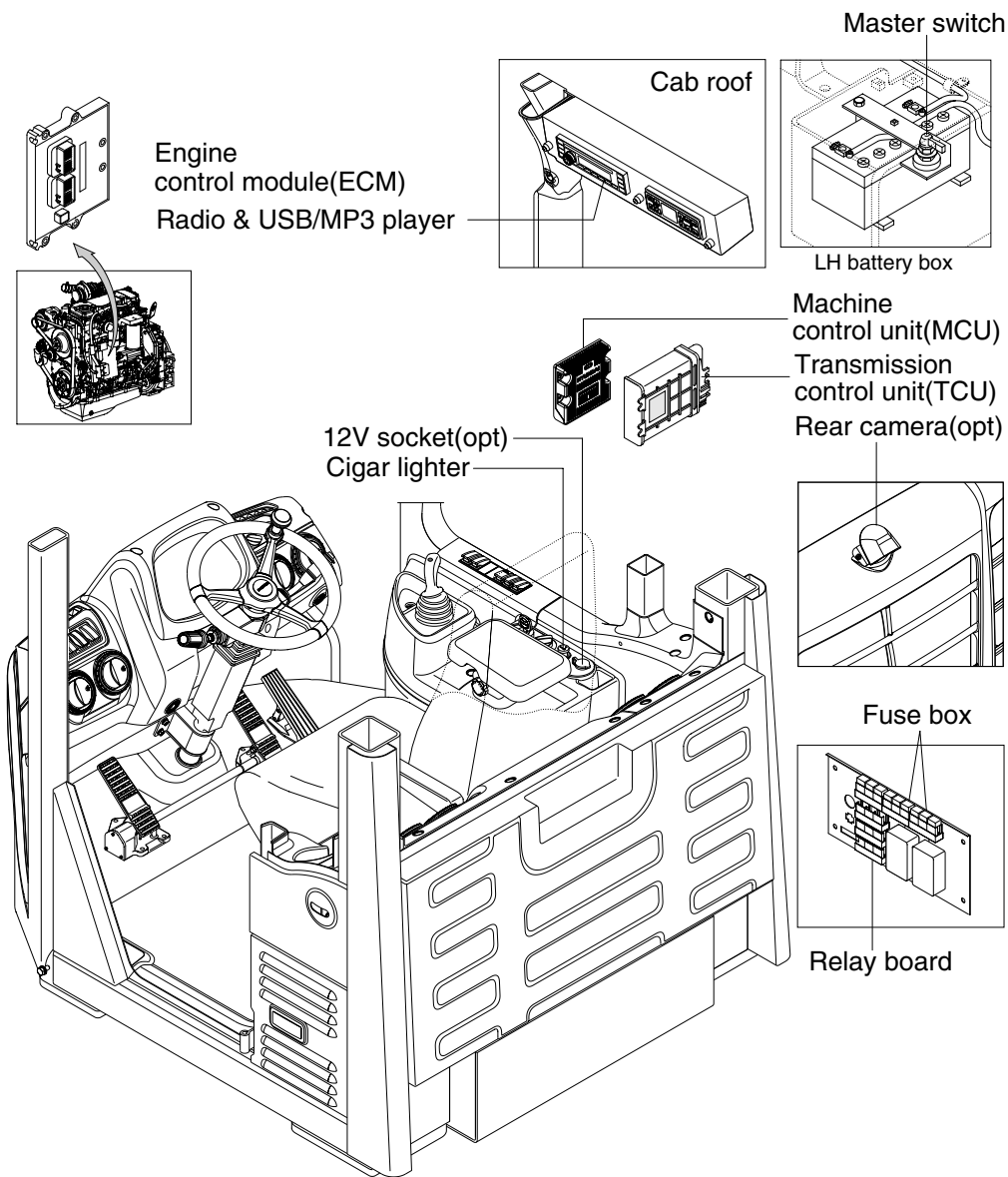

73093CD38

1) CIGAR LIGHTER

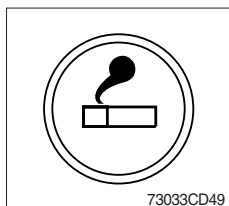

- (1) This can be used when the engine starting switch is ON.
- (2) The lighter can be used when it springs out in a short while after being pressed down.

※ **Service socket**

**Use cigar lighter socket when you need emergency power.
Do not use the lighter exceeding 24 V, 100 W.**

2) SEAT

The seat is adjustable to fit the contours of the operator's body. It will reduce operator fatigue due to long work hours and enhance work efficiency.

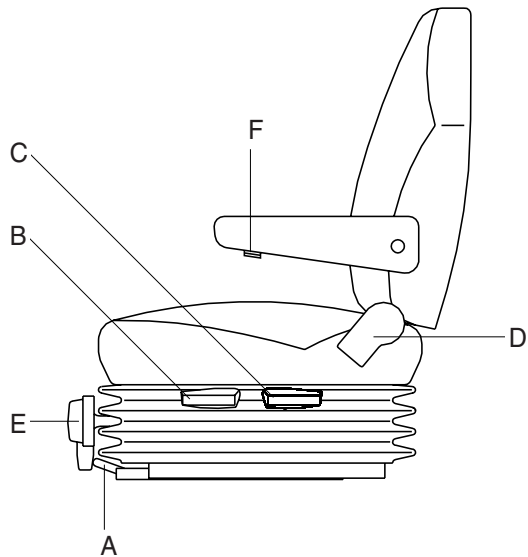

73033CD50

(1) Forward/Backward adjustment

- ① Pull lever A to adjust seat forward or backward.
- ② The seat can be moved forward and backward over 210 mm (8 in) in 21 steps.

(2) Upward/Downward adjustment

- ① Pull lever B and C to adjust seat upward or downward.
- ② Forward or backward side adjustment only can be made, tilting to one side, by moving lever B or C, respectively.

(3) Reclining adjustment

Pull lever D to adjust seat back rest.

(4) Arm rest adjustment

This can be adjusted by turning the handle F to right and left.

(5) Cushion adjustment (E)

Adjusting handle to the operator's weight.

3) 12V SOCKET (option)

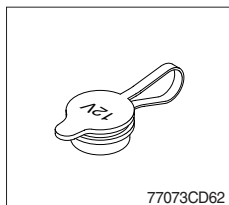

77073CD62

- (1) Utilize the power of 12 V as your need and do not exceed power of 12 V, 30 W.

4) MASTER SWITCH

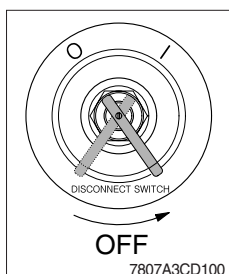

7807A3CD100

- (1) This switch is used to shut off the entire electrical system.
 - (2) I : The battery remains connected to the electrical system.
O : The battery is disconnected to the electrical system.
- ※ **Never turn the master switch to O (OFF) with the engine running. Engine and electrical system damage could result.**

5) FUSE BOX

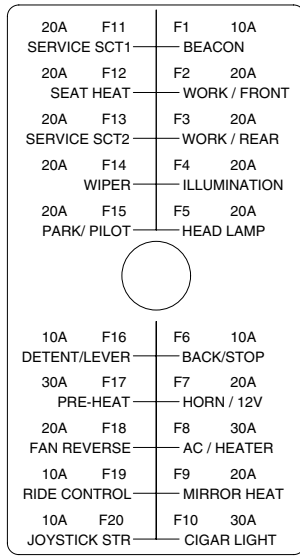

UPPER

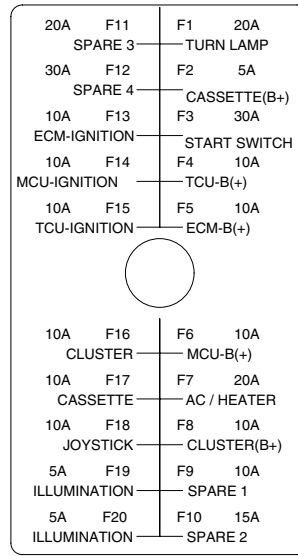

LOWER

75793CD40

- (1) The fuses protect the electrical parts and wiring from burning out.
 - (2) The fuse box cover indicates the capacity of each fuse and circuit it protects.
- ※ Replace a fuse with another of the same capacity.
- ▲ Before replacing a fuse, be sure to turn OFF the starting switch.

6) MACHINE CONTROL UNIT (MCU)

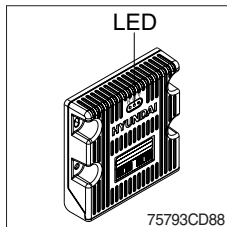

(1) It consists of electronic parts and controls all lamps and buzzers on cluster in accordance with signals transmitted from the switches, the ECM, TCU, the engine and the hydraulic pressure sensors.

(2) Three LED lamps on the MCU display as below.

LED lamp	Trouble	Service
G is turned ON	Normal	-
G and R are turned ON	Trouble on MCU	· Change the MCU
G and Y are turned ON	Trouble on serial communication line	· Check if serial communication lines between controller and cluster are disconnected
Three LED are turned OFF	Trouble on MCU power	· Check if the input power wire (24V, GND) of controller is disconnected · Check the fuse

G : green, R : red, Y : yellow

7) TRANSMISSION CONTROL UNIT (TCU)

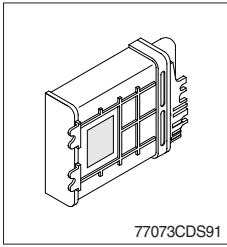

(1) The control unit is shifting the required speeds fully-automatically under consideration of the following criteria.

- Gear selector lever position
- Driving speed
- Load level

8) ENGINE CONTROL UNIT (ECU)

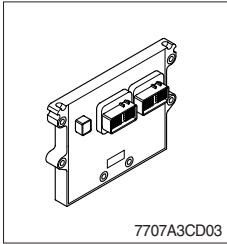

(1) The engine control unit (ECU) is the control center of the engine system.

9) REAR CAMERA (option)

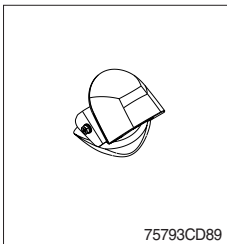

(1) The rear camera is available as a option.















※ Refer to page 3-24.

10) RADIO AND USB / MP3 PLAYER



75793CD62

■ FRONT PANEL PRESENTATION

- | | |
|--|---|
| <p>1  Sound function selection button (audio selection)</p> <p>2  Power and volume button</p> <p>3  Mode button (select RADIO / USB / AUX)</p> <p>4  UP / DOWN tuning button</p> <p>5  Preset memory button 1
DISP ID3 v2 display</p> <p>6  Preset memory button 2
SCN File scan</p> <p>7  Preset memory button 3
RPT Repeat play selector</p> <p>8  Preset memory button 4
RDM Random play selector</p> <p>9  Preset memory button 5
D- Directory down</p> | <p>10  Preset memory button 6
D+ Directory up</p> <p>11  Aux function</p> <p>12  Preset scan (PS)
Best station memory (BSM)</p> <p>13  Audio mute button</p> <p>14  AM / FM button (radio)</p> |
|--|---|

■ GENERAL

(1) Power and volume button

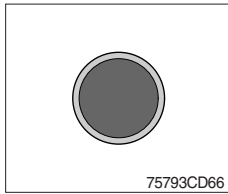

① Power ON/OFF button

Press power button to turn the unit ON or OFF shortly.

When the power is ON, the previous mode (last memory) will appear.

② Volume up / down control

Turn volume up / down button right to increase the volume level. The level will be shown in VOLUME xx on the LCD display. Turn it left to decrease the volume level. After 5 seconds of volume indication, display will return to the previous mode.

(2) Sound function selection button (audio selection)

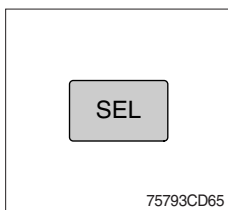

① This button is to adjust the sound. Each time you press power button shortly, LCD displays each mode as follows :

BASS → TREBLE → BAL → BEEP → LOUD → VOLUME
↑

※ When this button is pressed, LCD display shows selected function for 5 seconds and then returns back to the previous mode. On selected function, level can be controlled by turning this button. The display will automatically return to normal indication in 5 seconds after the last adjustment is made or when another function is activated.

② Bass control

To adjust the bass level, first select the bass mode by pressing the select button  until BASS indication appears on the LCD display. Within 5 seconds of choosing the bass mode, turn power button right / left to adjust the bass level as desired.

The bass level will be shown on the LCD display from a minimum of BASS -10 to a maximum of BASS +10.

The display will automatically return to the normal indication in 5 seconds after the last adjustment or when another function is activated.

③ Treble control

To adjust the treble level, first select the treble mode by pressing the select button  until TREBLE indication appears on the LCD display. Within 5 seconds of choosing the treble mode, turn power button right / left to adjust the treble level as desired.

The treble level will be shown on the LCD display from a minimum of TREBLE -10 to a maximum of TREBLE +10.

The display will automatically return to the normal indication in 5 seconds after the last adjustment or when another function is activated.

④ Balance control

To adjust the left-right speaker balance, first select the balance mode by pressing the select button  until the BAL indication appears on the LCD display.

Within 5 seconds of choosing the balance mode, turn power button right / left to adjust the balance as desired.

The balance position will be shown on the LCD display from BAL 10L (full left) to BAL 10R (full right).

When the volume level between the left and right speakers is equal, BAL L=R will be shown on the LCD display panel.

The display will automatically return to the normal indication in 5 seconds after the last adjustment or when another function is activated.

⑤ Beep control

To adjust the beep mode, first select the beep mode by pressing the select button  until BEEP indication appears on the LCD display.

The beep mode will be shown on the LCD display from BEEP 2ND, BEEP OFF and BEEP ON by turning power button right / left.

The display will automatically return to the normal indication in 5 seconds after the last adjustment or when another function is activated.

Select BEEP ON when you wish to hear the BEEP sound whenever any function button is pressed.

Select BEEP 2ND when you wish to hear the BEEP sound whenever any tuner pre-set button and/or tune seek buttons are pressed for more than 3 seconds.

⑥ Loud control

When listening to music at low volume levels, this feature will boost the bass and treble response.

This action will compensate for the reduction in bass and treble performance experienced at low volume.

To select the loudness feature, press select button  until LOUD ON or LOUD OFF is displayed, then turn power button left or right to activate or deactivate loudness.

(3) Mode button

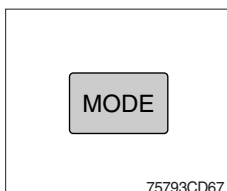

- ① Press mode button to select RADIO / USB / AUX.

(4) Audio mute button

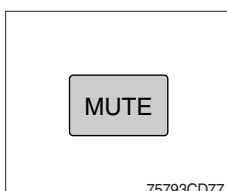

- ① Press mute button momentarily to mute volume and MUTE mark will blink on the LCD display. Press the button again to return to the mode in use before the mute mode was activated.

■ RADIO

(1) AM / FM / LW band selector

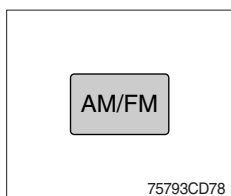

- ① Each time this button is pressed, the radio band is changed. Each time this button is pressed, LCD displays each band as follows :

FM1 → FM2 → FM3 → AM → LW

※ LW band is only available for Europe.

(2) Up / down tuning

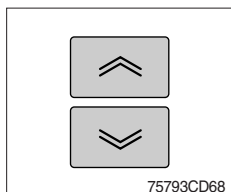

- ① To automatically select a radio station, momentarily press the up tune seek button \frown or down tune seek button \smile for less than 3 seconds to search for the closest radio station.

To manually select a radio station, press the up tuning & down tuning button for longer than 3 seconds.

The radio frequency will move up or down step by step each time you press button.

(3) Station pre-set button

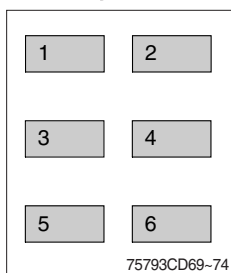

- ① Pressing these buttons shortly will recall your favorite pre-set radio stations.

To store your favorite stations into any of the 6 pre-set memories in each band (AM/FM/LW), use the following procedure :

- a. Turn the radio ON and select the desired band.
- b. Select the first station to be pre-set using the manual up/down or automatic seek tuning control button.
- c. Press the chosen pre-set button to store your selected station into and continue to hold it in. The beep sound will be momentarily heard and the pre-set number will appear on the LCD display indicating that the station is now set into that pre-set memory position and can be recalled at any time, by pressing that pre-set button.

(4) Pre-set scan (PS) / Best station memory (BSM) button

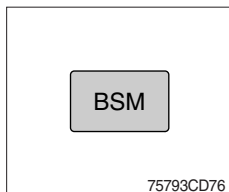

① Pre-set scan (PS)

Press BSM button shortly to scan the 6 pre-set station stored the memories on each band (AM/FM/LW).

The unit will stop at each pre-set station (the pre-set number on the LCD display will flash during pre-set scan operation) and remain on the selected frequency. Press the button momentarily again to remain on the station currently being heard.

② Best station memory (BSM)

Pressing BSM button for longer than 2 seconds will activate the BSM tuning feature which will automatically scan and enter each station into memory.

If you have already set the pre-set memories to your favorite stations, activating the BSM tuning feature will erase those stations and enter the new ones.

This BSM feature is most useful when traveling in a new area where you are not familiar with the local stations.

■ USB PLAYER

(1) USB function



75793CD81

- ① Connect a USB device through USB/AUX cable if you want to listen to MP3 file in a USB device.
- ② If a USB device is not connected before, MP3 files in USB device will be playing by automatically changing to USB mode when a USB device is inserted.
- ③ If a USB device is already inserted, MP3 files in a USB device will be playing after changing USB mode by pressing MODE button.

(4) ID3 v2 display

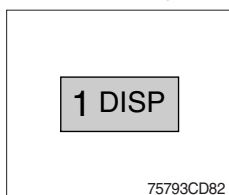

- ① Disp button is used to change the display information. While playing an MP3 file, you can change the file information shown on the LCD display. Each time you press DISP (display), the display changes to show the following.
- ※ If the MP3 disc does not have any ID3 information, the display will show NO ID3 on LCD display.

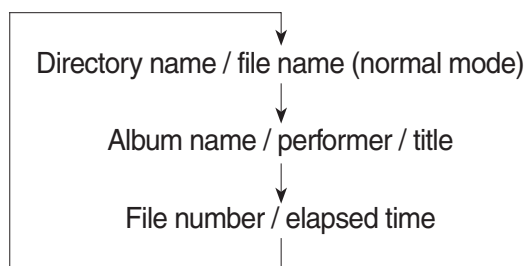

(5) File scan (SCN)

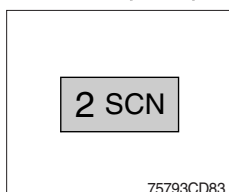

- ① During USB play, press SCN button to play the first 10 seconds of each file on the whole file on the USB (SCN mark will appear on the LCD display). When a desired file is reached, press the SCN button again to cancel the function. The unit will then play the selected file.
- ※ In case of playing MP3 file, when the SCN (scan) button is pressed and held for longer than 2 seconds, the SCN mark will blink on the LCD display and all files in the selected directory will be introduced until the file scan mode is cancelled by pressing the SCN button again or by activating the random or repeat functions.

(6) Repeat play selector (RPT)

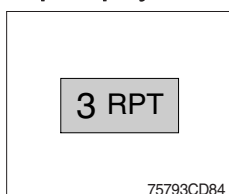

- ① During USB play, press RPT button to play the selected file repeatedly (RPT will appear on the LCD display). Play of the file will continue to repeat until this button is pressed again and the RPT disappears from the LCD display.
- ※ In case of playing MP3 file, when the RPT button is pressed and held longer than 2 seconds, the RPT mark will blink on the LCD display and play all files in the selected directory and will be repeated until the directory repeat mode is cancelled by pressing the repeat button again or by activating the scan or random functions (RPT mark will disappear from LCD display).

(7) Random play selector (RDM)

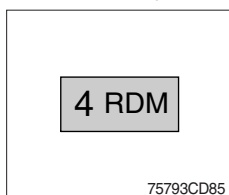

① During USB play, press RDM button to play the files on the USB in a random shuffled order (RDM will appear on the LCD display). The file select function will also select file in the random order instead of the normal process.

The random play mode can be cancelled by this button again.

※ In case of MP3 file, when the random button is pressed and held longer than 2 seconds, the RDM mark will blink on the LCD display and play all files in directory randomly until the directory random mode is cancelled by pressing the random button again or by activating the scan or repeat functions (RDM mark will disappear from LCD display).

(8) Directory down

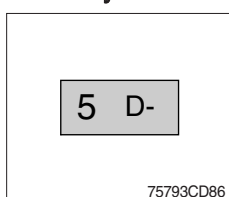

① Press D- button briefly while playing MP3. The previous directory is located each time you press this button.

(9) Directory up

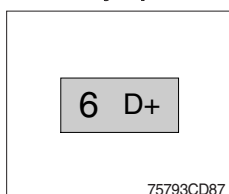

① Press D+ button briefly while playing MP3 . The next directory is located each time you press this button.

※ If the MP3 file does not have a directory, the unit play MP3 at 10-file intervals.

※ If any MP3 file does not exist in USB, this button can not operate.

■ AUX PLAYER

(1) Aux function

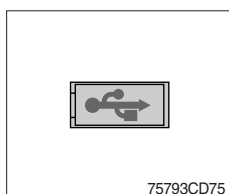

① If you want to listen to music of a external audio device, connect a external audio device through USB/AUX cable.

② Change AUX mode by pressing MODE button.

If audio file of audio device is playing, you can listen to music through car audio speaker.