

## 6. OTHERS

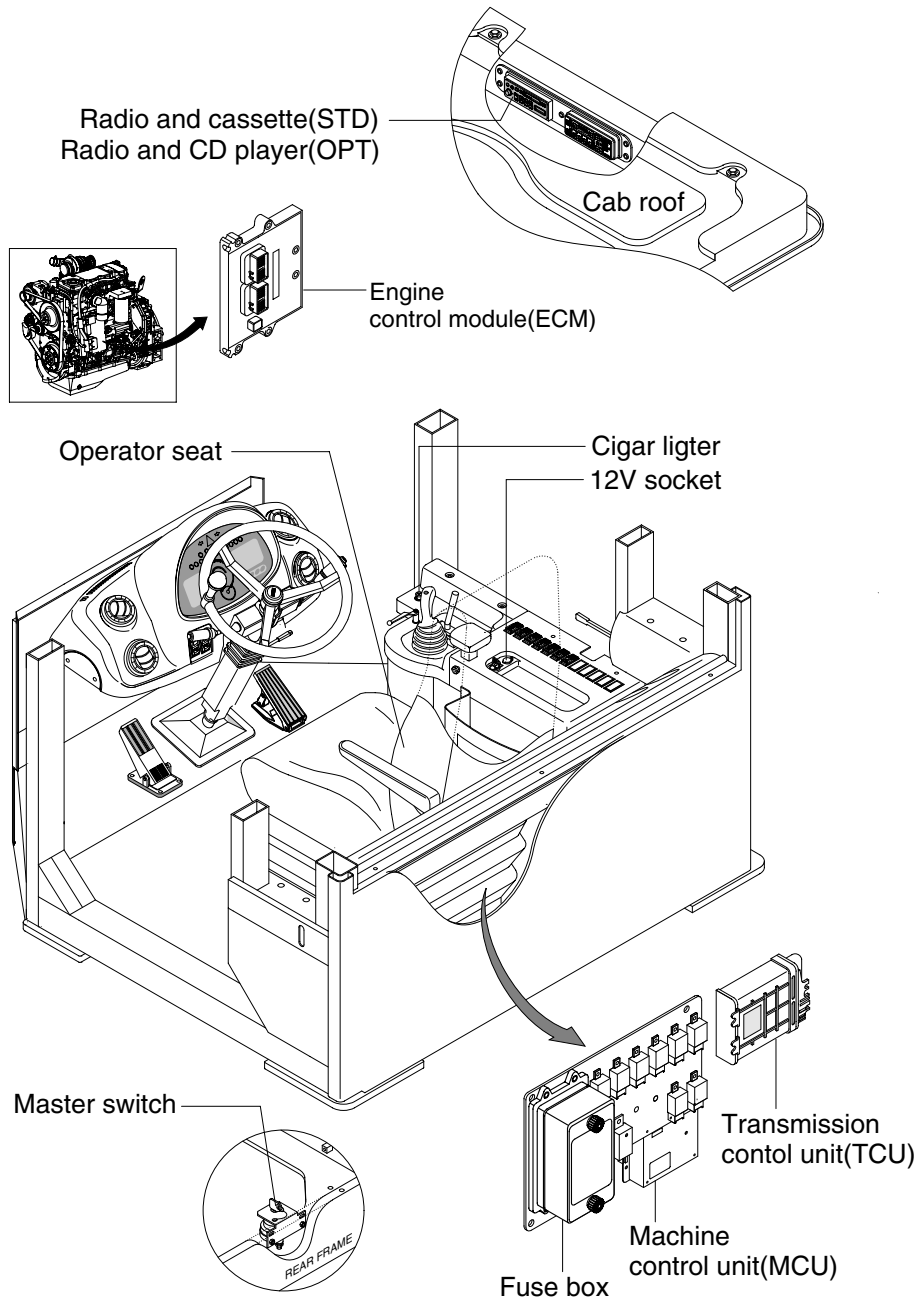

7307A3CD10

### 1) CIGAR LIGHTER

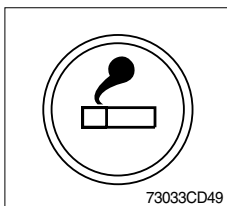

- (1) This can be used when the engine starting switch is ON.
- (2) The lighter can be used when it springs out in a short while after being pressed down.

※ **Service socket**

**Use cigar lighter socket when you need emergency power.  
Do not use the lighter exceeding 24V, 100W.**

## 2) SEAT

The seat is adjustable to fit the contours of the operator's body. It will reduce operator fatigue due to long work hours and enhance work efficiency.

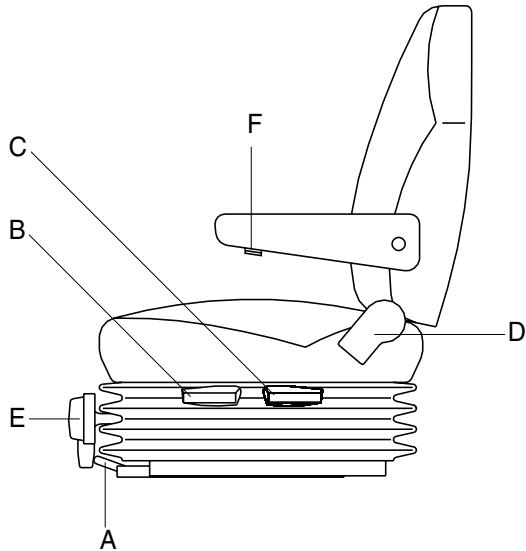

73033CD50

### (1) Forward/Backward adjustment

- ① Pull lever A to adjust seat forward or backward.
- ② The seat can be moved forward and backward over 200mm(8in) in 10 steps.

### (2) Upward/Downward adjustment

- ① Pull lever B and C to adjust seat upward or downward.
- ② Forward or backward side adjustment only can be made, tilting to one side, by moving lever B or C, respectively.

### (3) Reclining adjustment

Pull lever D to adjust seat back rest.

### (4) Arm rest adjustment

This can be adjusted by turning the handle F to right and left.

### (5) Cushion adjustment (E)

Adjusting handle to the operator's weight.

## 3) 12V SOCKET (Option)

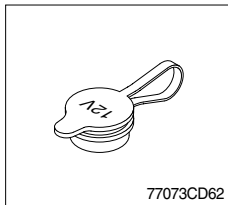

77073CD62

- (1) Utilize the power of 12V as your need and do not exceed power of 12V, 30W.

## 4) MASTER SWITCH

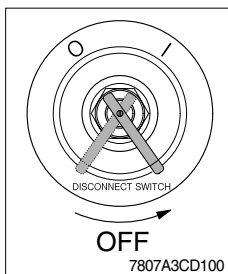

7807A3CD100

- (1) This switch is used to shut off the entire electrical system.
  - (2) I : The battery remains connected to the electrical system.  
O : The battery is disconnected to the electrical system.
- ※ **Never turn the master switch to O(OFF) with the engine running. Engine and electrical system damage could result.**

## 5) FUSE BOX

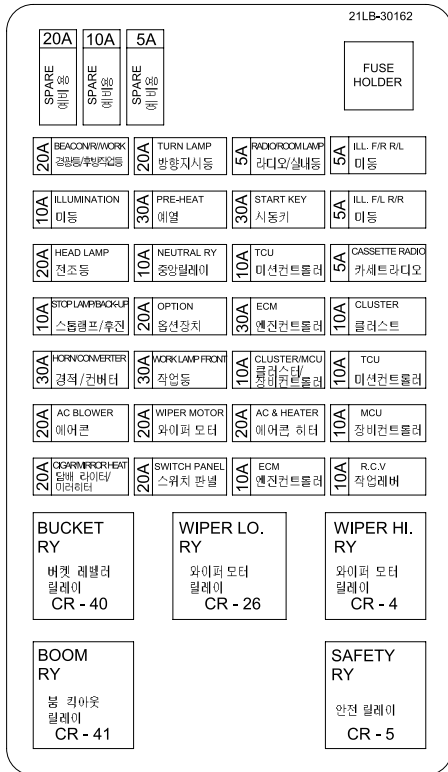

7807A3CD40

(1) The fuses protect the electrical parts and wiring from burning out.

(2) The fuse box cover indicates the capacity of each fuse and circuit it protects.

※ Replace a fuse with another of the same capacity.

▲ Before replacing a fuse, be sure to turn OFF the starting switch.

## 6) MACHINE CONTROL UNIT(MCU)

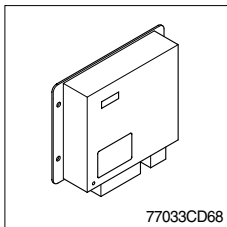

(1) It consists of electronic parts and controls all lamps and buzzers on cluster in accordance with signals transmitted from the switches, the ECM, TCU, the engine and the hydraulic pressure sensors.

## 7) TRANSMISSION CONTROL UNIT(TCU)

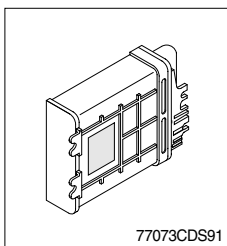

(1) The control unit is shifting the required speeds fully-automatically under consideration of the following criteria.

- Gear selector lever position
- Driving speed
- Load level

## 8) ENGINE CONTROL MODULE(ECM)

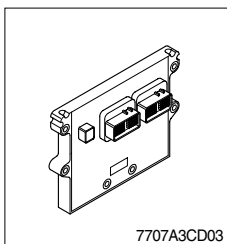

(1) The engine control module(ECM) is the control center of the engine system.

## 9) RADIO AND CASSETTE(Standard)

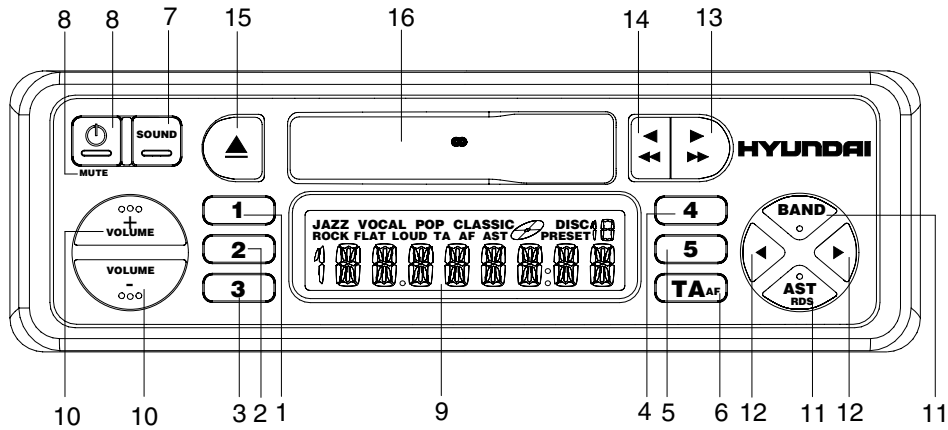

7807A3CD81

## RADIO AND CD PLAYER(Optional)

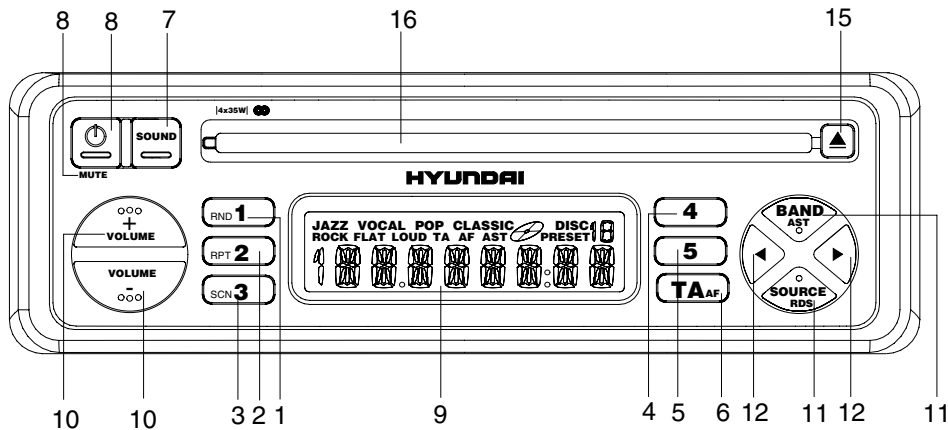

7807A3CD82

### ■ FRONT PANEL PRESENTATION

- |    |   |    |  |
|----|---|----|--|
| 1  | <b>1</b> ..... Preset button 1  | 11 | <b>SOURCE</b> .. Short press : Change source(CD) |
|    | <b>RND</b> ..... CD random playback on/off  |    | <b>RDS</b> ..... Long press : RDS on/off         |
| 2  | <b>2</b> ..... Preset button 2  |    | <b>BAND</b> ..... Short press : To select band   |
|    | <b>RPT</b> ..... CD repeat track on/off   |    | <b>AST</b> ..... Long press : Autostore(CD)      |
| 3  | <b>3</b> ..... Preset button 3  |    | Short press : Autostore(Cassette)                |
|    | <b>SCN</b> ..... CD's track scan  | 12 | <b>◀▶</b> ..... <b>Tuner mode</b>                |
| 4  | <b>4</b> ..... Preset button 4  |    | Short press : Auto search up/down                |
| 5  | <b>5</b> ..... Preset button 5  |    | Long press : Manual search up/down               |
| 6  | <b>TA/AF</b> ..... Short press : TA on/off  |    | <b>Cassette mode</b> : No function               |
|    | Long press : AF on/off  |    | <b>CD mode</b>                                   |
| 7  | <b>SOUND</b> ..... Select sound/audio styles  |    | Short press : Next/previous track                |
| 8  | <b>⏻</b> ..... Short press : power on   |    | Long press : Fast forward or fast rewind         |
|    | Long press : power off  | 13 | <b>▶▶</b> ..... Fast forward(cassette deck)      |
|    | <b>MUTE</b> ..... Short press : To mute or cancel mute.                             | 14 | <b>◀◀</b> ..... Fast rewind(cassette deck)       |
| 9  | ..... Display   | 15 | <b>▲</b> ..... Disc eject(CD)                    |
| 10 | ..... Volume knob : Press up/down to adjust the volume ; adjust selected audio mode |    | Eject cassette                                   |
|    |   | 16 | ..... CD opening / Cassette opening              |

■ AUDIO

(1) Power and mute button

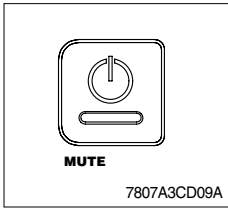

① POWER ON/OFF

Press to switch on the set. Press for more than 2 seconds to switch off the set.

② MUTE(Silence)

Short press key to mute or cancel the mute(silence).

※ The silence period may be interrupted by ALARM announcement or traffic announcement messages(if TA is switched on).

(2) Volume button

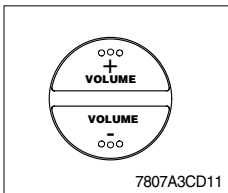

① Press the volume button up/down to adjust the volume.

Please make sure you can still hear the traffic(horns, sirens..).

(3) Sound button

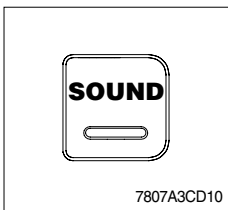

① SOUND

Whether you listen to Jazz, Vocal, Pop, Classic or Rock music, the SOUND button is the perfect setting for your choice.

- Press SOUND then the sound button to select BASS-Treb for your own sound style, or adjust the settings with the volume up/down buttons to select one of the pre define sound styles:

- BASE -TRE : Your own settings of bass and treble.
- FLAT : Original
- JAZZ : Jazz music
- VOCAL : Speech
- POP : Pop music
- CLASSIC : Classical music
- ROCK : Rock music

② AUDIO SETTING

- Press SOUND to select desired audio mode.
- Adjust the settings with the volume up/down buttons :

- Sound style : BASS-TRE, FLAT, JAZZ, VOCAL, POP, CLASSIC, ROCK
- BASS : Low notes
- TREBLE : High notes
- BALANCE : Left-right
- FADER : Rear-front
- LOUD : OFF, LOW, MID, HIGH

- Press the volume button to adjust the selected audio mode. After 5 seconds the display goes back to the last mode of operation. Adjustment of Bass and Treble settings is only possible when BASS-TRE is selected as the sound style.

#### (4) Source button

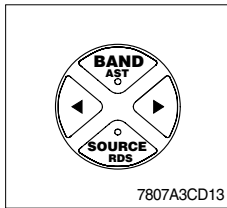

① Press SOURCE to select the desired source :

↻ - TUNER  
↻ - CD

※ Products with cassette mechanism will change source to cassette only when a tape is inserted.

### ■ RADIO

#### (1) Wave band / Automatic search button

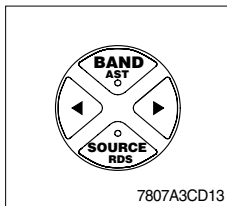

##### ① WAVEBAND

· Press BAND to select the desired band:

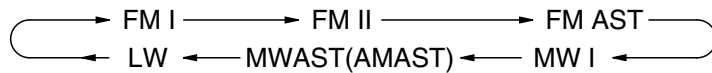

##### ② AUTOMATIC SEARCH

Use search tuning to automatically search for a station.

- Press ◀ to tune a station of a lower frequency or ▶ to a higher frequency.
- To search for another station, press the key again.

##### ③ MANUAL TUNING(If you know the frequency of the required station)

· To switch to manual tuning :

- Long press the search button ◀ or ▶ for more than 2 seconds will switch the tuning to manual tuning.
- Then press ◀ to tune to a station of a lower frequency or ▶ to a higher frequency.
- When keys are released, a time-out start to count. After 5 seconds time-out, display 'Auto' for one second and return to automatic search.

## (2) Preselected button

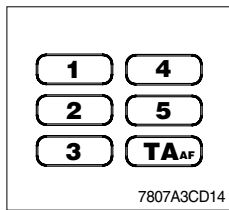

### Preselected stations

#### ① Manually storing stations in a preset

Five stations per band can be stored and recalled using the preset keys(1 to 5).

- Tune in to the desired station.
- Press the desired preset key(1 to 5) for more than 2 seconds to store the current tuned station.

**When storing an FM station, the current program station name and the AF mode are stored on the preset(Some stations use alternating program service name).**

#### ② Recalling a preset

Press the desired preset key(1 to 5) to recall the stored station.

#### ③ Automatically storing stations(AUTO-STORE)

You can automatically store 5 strongest FM stations on the FM AST band or 5 strongest MW(AM) stations on the MW(AM) AST band. When you use Auto store, the new stations replace any stations previously stored in the FM AST band or the MW(AM) AST band.

- Press AST to activate autostore.
- The set gives a beep and then mutes.
- When it has finished, you hear a beep followed by the station stored on preset 1.
- Sometimes it may not be possible to find 5 stations.

## ■ RADIO DATA SYSTEM(RDS) ON FM

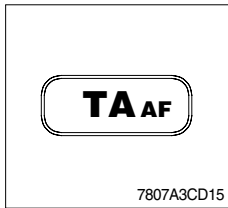

More and more stations broadcasts RDS informations in order to offer you many advantages including:

### (1) Program service name(PS)

Allows the radio to display the name of the station instead of its frequency.

### (2) Automatic returning(AF)

The set remains tuned to the current station by continually searching the best alternative frequency for best reception.

You can switch AF off.

#### - Activate/Deactivate AF

This set continuously search for other alternative frequencies for the tuned radio station and automatically selects the best frequency for reception. Long press  for more than 2 second to activate/deactivate AF.

### (3) Alarm messages(PHY ALARM)

This set automatically receives emergency messages made by the broadcaster.

- During the messages the display shows 'ALARM' and the station-name alternately.

### (4) Traffic announcements(TA)

You can activate the TA modes to give priority so as to hear traffic announcements related to these subjects(even if you play a cassettes/CD or mute the set).

#### - Activate/Deactivate TA

- Short press BAND to select an FM band.
- Press  to activate/deactivate TA.

#### - If you activate TA mode

- You will hear the traffic announcements when broadcast by station(even if you play a cassette/CD or mute the set).
- If the tuned station does not enable the reception of traffic announcements, the display shows 'NO TA'. The radio automatically searches and appropriate station.

#### - Interrupting traffic announcement mode

If you do not wish to continue listening to a particular traffic announcement

- Short press  key to interrupt traffic announcement without switching off the mode
- The set will return to the previous operating mode.

#### ※ You can switch off RDS features if not required.

- Long press RDS key to switch off RDS.
- All RDS related features e.g., TA, etc...will be deactivated when RDS is switch off.

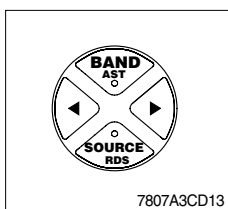

## ■ CASSETTE PLAYER

### (1) Winding/Rewinding button

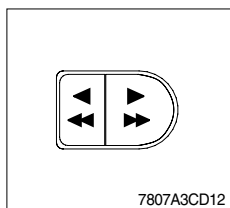

- ※ Only use good quality cassettes.
- ※ To avoid possible tape damage always take out the cassette after use. Protect your cassettes. Put them back in their boxes immediately after use.
- ※ Never expose cassettes to heat or direct sunlight.

#### ① Play back

Slide the cassette, with the open side to the right into the cassette opening. Playback starts.

The direction of playback is shown by indicator ► .

#### ② Stopping playback( ▲ )

- To stop playback, Press the ▲ button fully home.
- The unit will switch over to radio reception.
- The cassette is partially ejected.

#### ③ Reverse(before the end of the tape)

Press the ◀◀ and ▶▶ buttons at the same time halfway in.

#### ④ Fast rewind / Fast forward(◀◀ or ▶▶ )

The direction of fast winding depends on the direction of play indicated on the display.

Display during playback	Action	Key to press
►	Fast forward	▶▶
▶	Fast rewind	◀◀
◀	Fast forward	◀◀
◀	Fast rewind	▶▶

During fast forward or rewind the radio resumes. If you continue fast winding until the end of the tape, play back restarts automatically.

#### ⑤ To stop fast winding

To stop fast winding before the end of the tape, press the key which is not pressed(◀◀ or ▶▶). Playback is then resumed.

#### ⑥ End of the tape

At the end of the tape, playback continues in the revers direction.

#### ⑦ Maintenance

After extended use of the cassette player, dust, contamination or grime can accumulate on the playback head.

This results in diminishing high-note reproduction. This can be remedied using a cleaning cassette(one or twice a month) and playing it through like an ordinary cassette.

## ■ CD PLAYER

### (1) Winding / Rewinding button

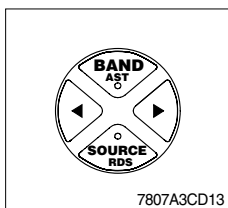

#### ① CD playback

This CD player is suitable only for 12cm disc, do not use irregular shaped CD.

- Slide the disc into the slot with label facing upwards. Playback starts.
- If a disc is already inserted :  
Press SOURCE to select CD as the source.  
Playback starts.

#### ② Previous / Next track(◀ or ▶)

- Short press the ◀ or ▶ button to select the desired track.
- Playback resume with the chosen track.

#### ③ Fast rewind / Fast forward(◀◀ or ▶▶)

- Long press the ◀◀ or ▶▶ button for more than 2 seconds to quickly move rewind or forward through the disc.
- Normal play back resumes when you release the button.

#### ④ Random track playback

- Press RND to activate / deactivate random track playback.

#### ⑤ Repeat track

- Press RPT to activate / deactivate repeat current track.

#### ⑥ Scan track

The scan function enables you to listen to the first few seconds of each track.

- Press SCN to activate / deactivate scan track.

#### ⑦ Disc eject

- Press  to eject the disc.

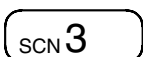
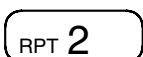
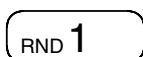

## ■ RADIO SETTING

