

2. SPECIFICATIONS

1. MAJOR COMPONENTS

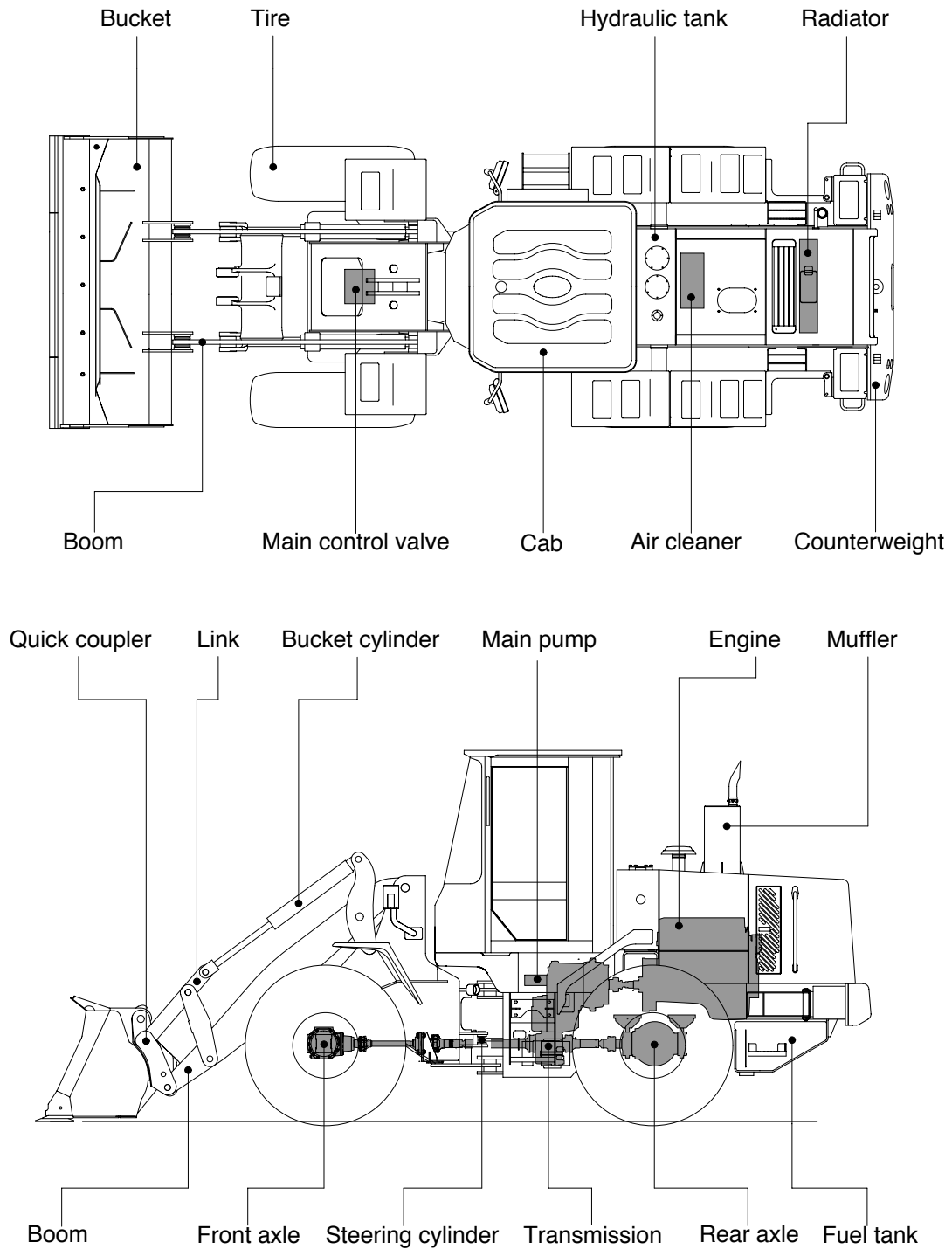

730TM72SP01