

2. SPECIFICATIONS

1. MAJOR COMPONENTS

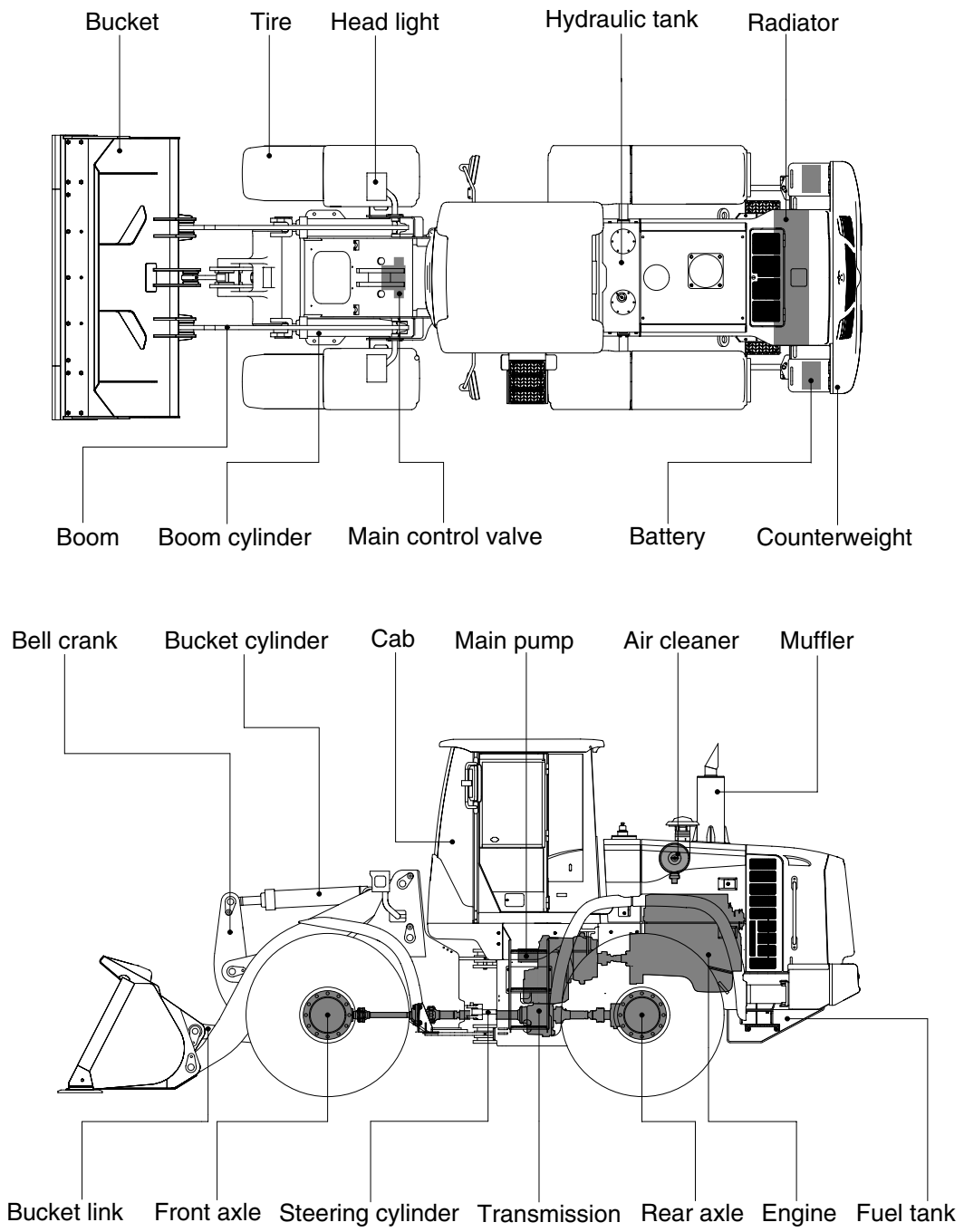

73092SP05