

## 2. SPECIFICATIONS

### 1. MAJOR COMPONENTS

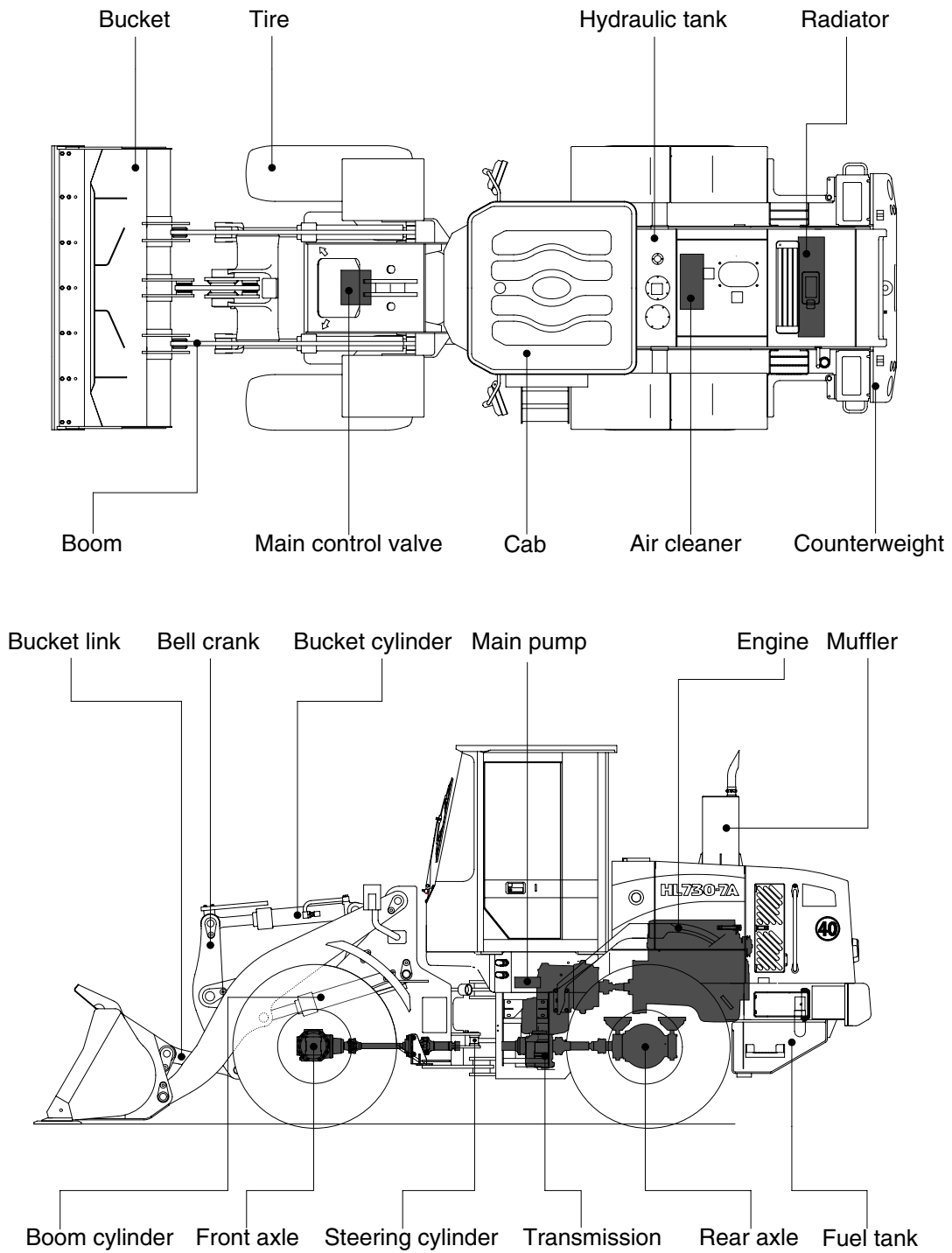

7307A2SP01